

WFIRST Coronagraph Low Order Wavefront Sensing and Control (LOWFS/C)

Fang Shi, K. Balasubramanian, R. Hein, J. Krist, R. Lam, M. Mandic, D. Moore, J. Moore, K. Patterson, I. Poberezhskiy, J. Shields, E. Sidick, H. Tang, T. Truong, J. K. Wallace, X. Wang, and D. Wilson

Jet Propulsion Laboratory
California Institute of Technology
Pasadena, California 91109

May 5, 2016



- WFIRST telescope line-of-sight jitter and wavefront drift
- Low order wavefront sensing and control (LOWFS/C) design for WFIRST Coronagraph
 - Zernike wavefront sensor
 - Control loop design for LoS drift and jitter
- OTA Simulator and LOWFS/C testbed
- Results from LOWFS/C testbed
- Summary and discussion

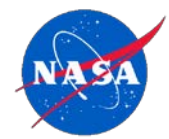

WFIRST Telescope LoS Jitter and WFE Drift **JPL**

- **Line-of-sight drift and jitter (Cycle 5 model)**

- Drift (<2Hz): ~14 milli-arcsec ACS pointing.
- Jitter (>2Hz): < 10 milli-arcsec. Most around 10 Hz with multiple harmonics at each RW speed.

- **RW induced WFE Jitter (Cycle 5 model)**

- High frequency WFE. Dominant WFE are: astig (Z5, Z6), coma (Z7, Z8), trefoil (Z9, Z10).
- Impact to coronagraph contrast is small.

- **WFE drift (Cycle 5 model)**

- Mostly thermal induced rigid body motion of the telescope optics.
- Slow varying, typically <10 pm/hour.
- Dominant WFE are: focus (Z4), Astigmatism (Z5, Z6) and coma (Z7, Z8).
- Severely depredate the coronagraph contrast if left un-corrected.

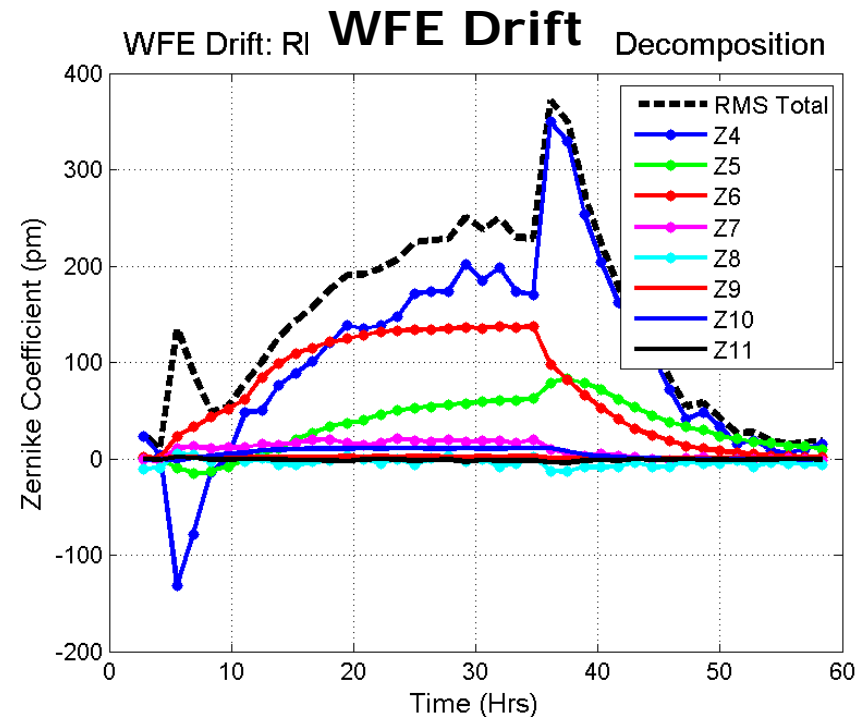
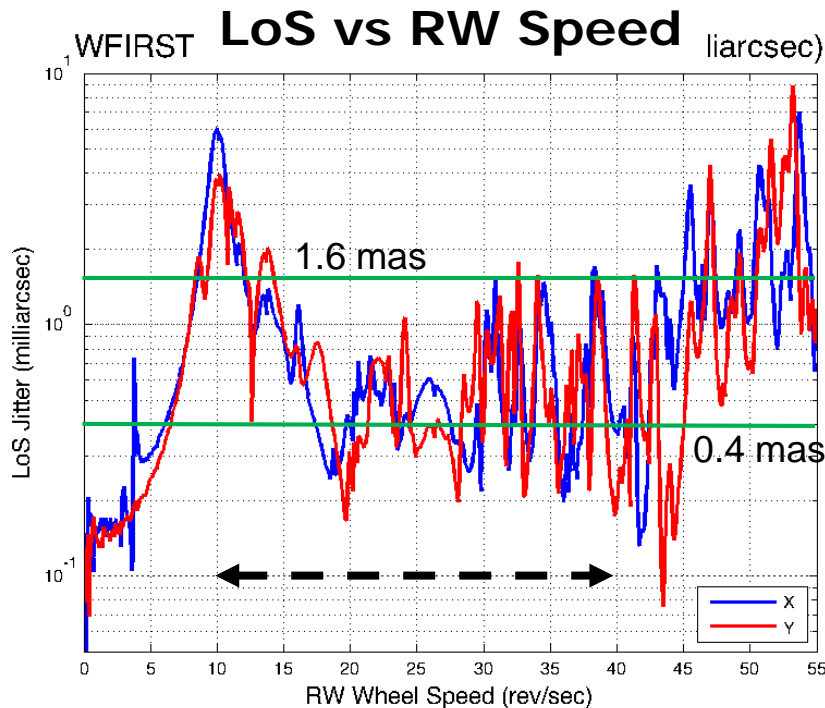

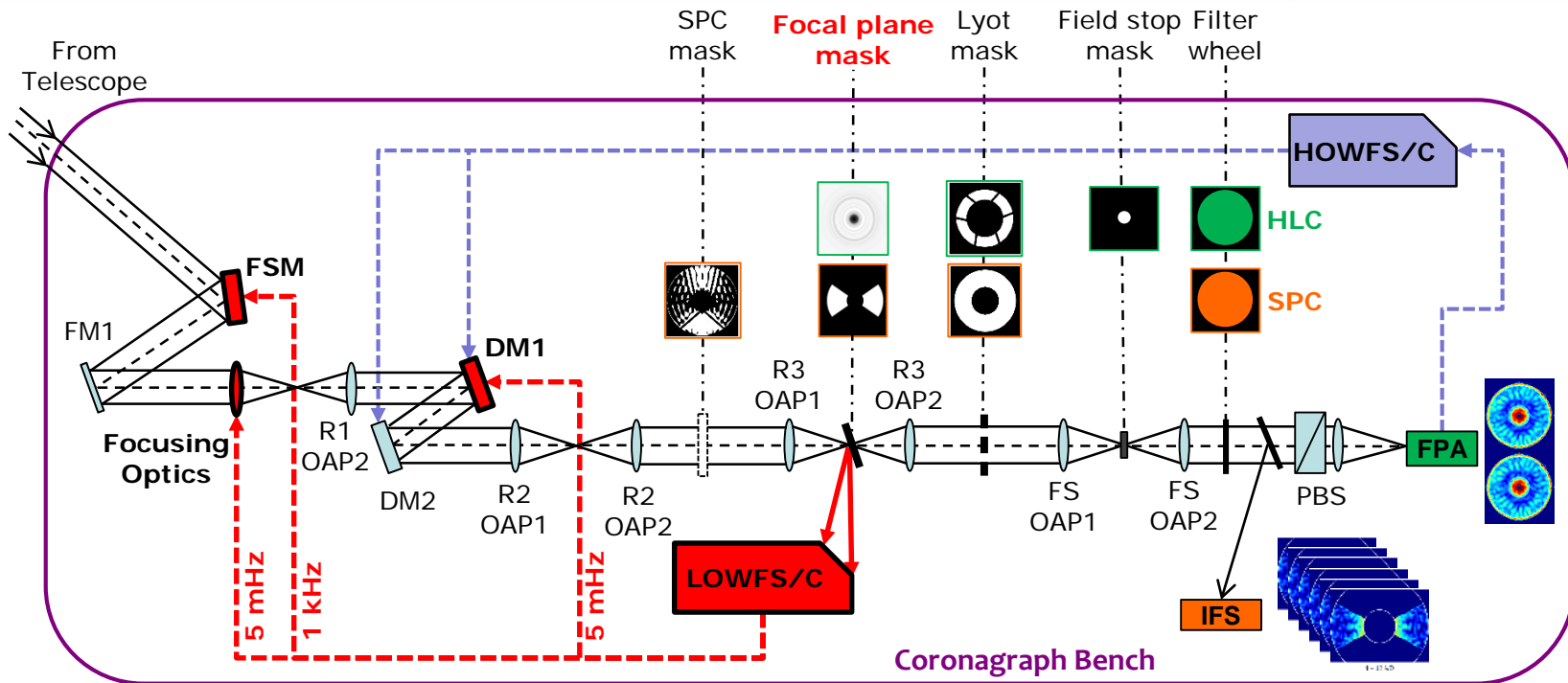

- WFIRST LOWFS/C subsystem measures and controls line-of-sight (LoS) jitter and drift as well as the thermally induced low order wavefront drift
- Differential sensor referenced to coronagraph wavefront control: maintains wavefront established for high contrast (HOWFS/C)
- Using rejected starlight from occulter which reduces non-common path error
- LOWFS/C telemetry can be used for coronagraph data post-processing

- Zernike WFS (ZWFS) measures wavefront error (WFE) from interference between the aberrated WF and the reference WF generated by a phase dimple (diameter $\sim \lambda/D$)
 - At phase shift of $\pi/2$, pupil image brightness variation is proportional to the WFE: $\Delta I \sim \pm 2\phi$
 - Same principle as Zernike phase contrast microscope
- ZWFS uses linearized differential image to sense the delta WFE
 - ZWFS sensed pupil is imaged to CCD at 16x16 pixels for sensing WFE up to spherical aberration (Z11)
 - 128 nm spectral band (traded-off throughput vs. accuracy)

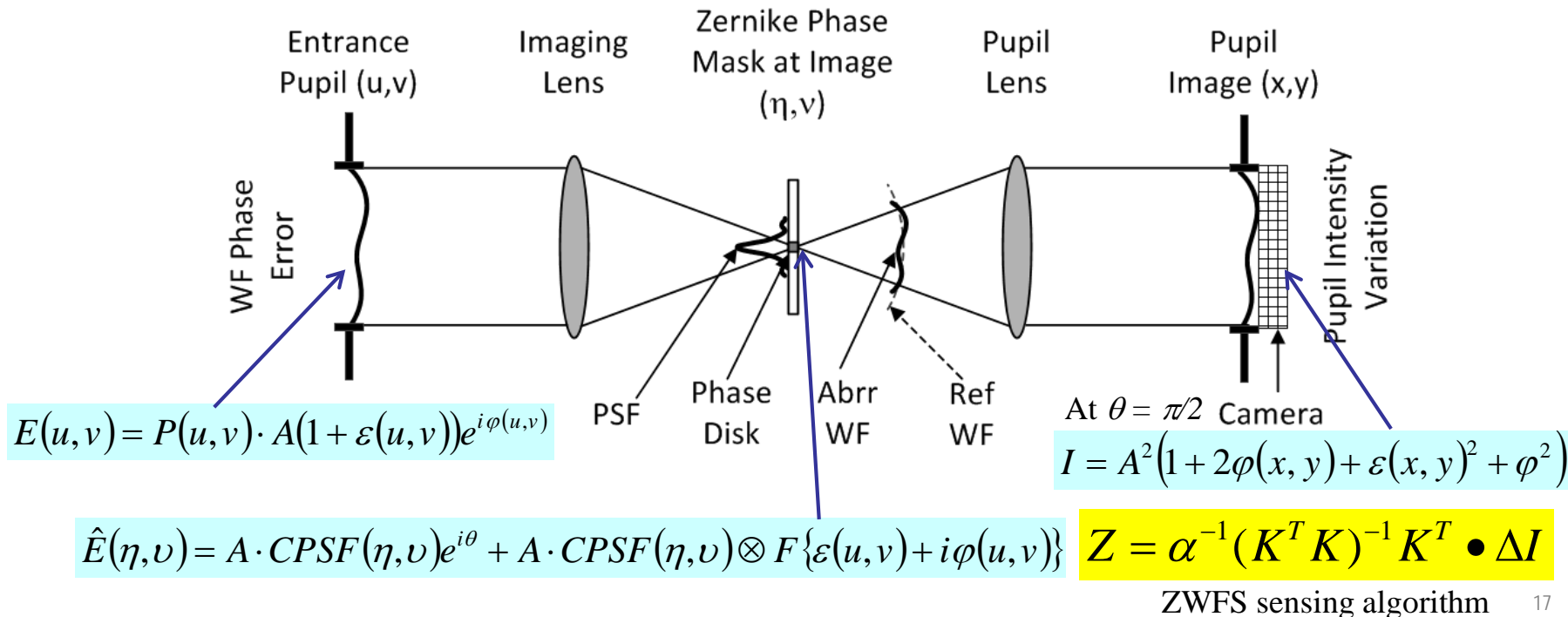

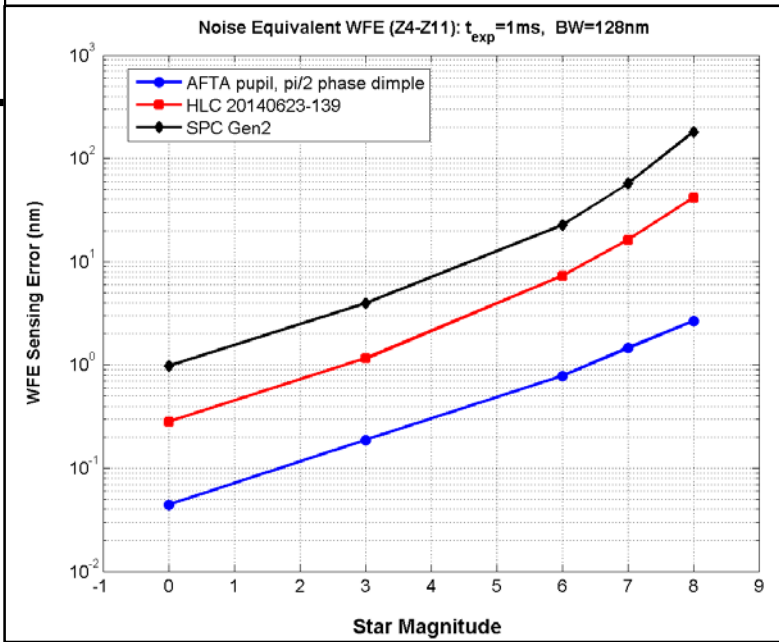
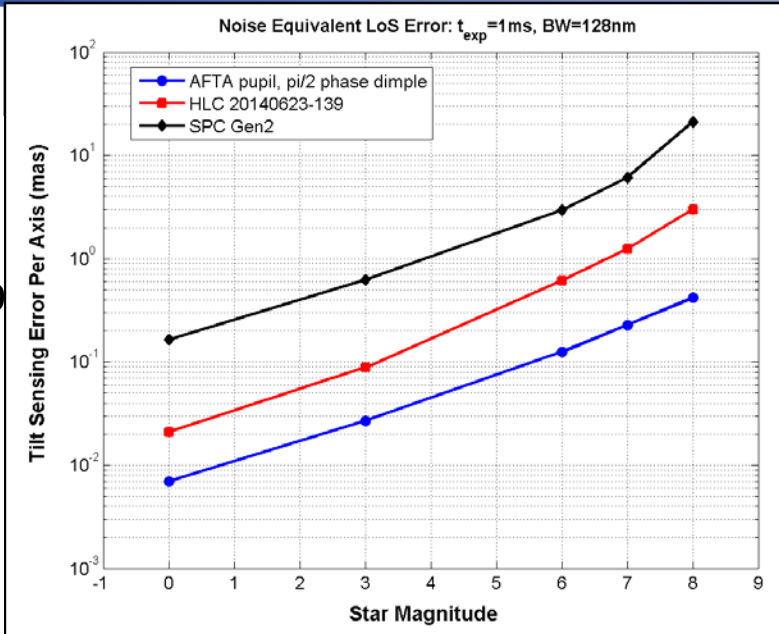

- Diffraction models of ZWFS for HLC and SPC used to analyze the ZWFS performance
- ZWFS noise equivalent errors (LoS and WFE)
 - PSF difference caused by diffraction (SPC) or DMs (HLC) increases the ZWFS sensing error
 - Plots on the left is ZWFS @ 1 msec exposure (CCD readout at 1 KHz)
- For slow varying WFE, image averaging will lower the equivalent M_V

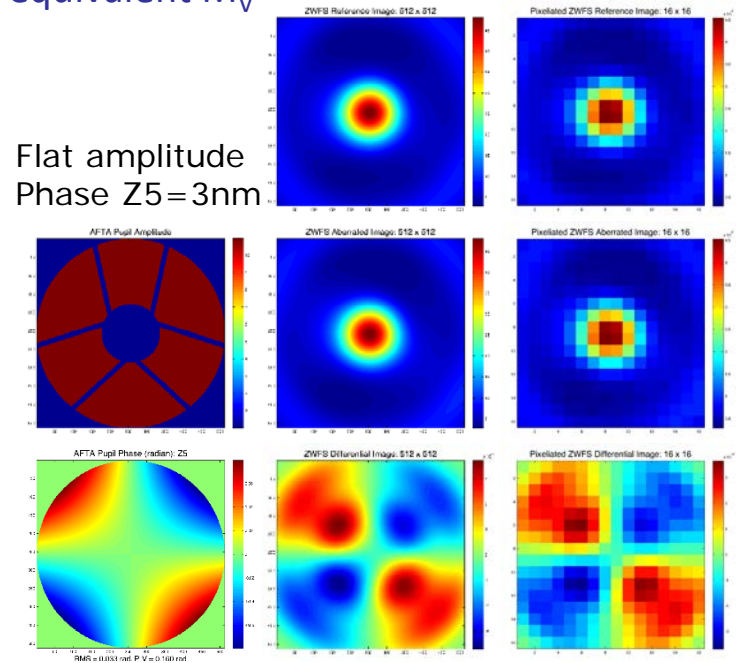

- ZWFS signal is the difference of the aberrated and the reference image.
- The signal strength is linearly proportional to the WFE level.
- ZWFS signal (diff. image) pixel is $\sim 3\%$ of the image pixel when the WFE ~ 1 nm.

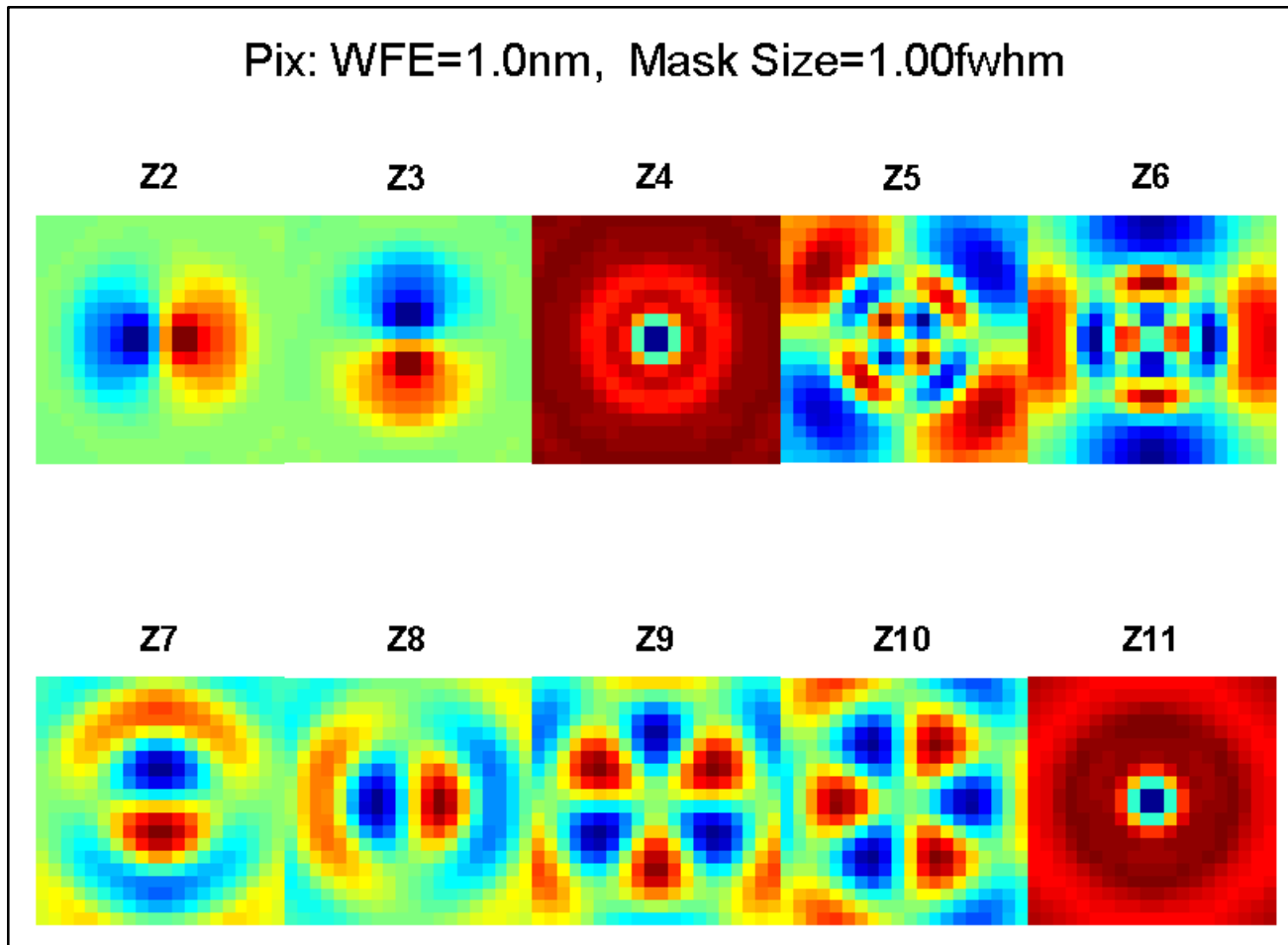

- **Feedback path to cancel slow ACS LoS drift**
 - The LOS loop is shaped for **optimal rejection of the ACS disturbance and LOWFS/C sensor noise**. This is done by balancing the error contribution from both sources of jitter, camera noise and ACS
- **Feedforward path to cancel high frequency tonal LoS jitter from RWAs**
 - RWA tones are attenuated using an least-mean-square (LMS) filter which sends commands to the feedback loop.
 - LMS estimates the gain and phase of the disturbance. RWA wheel speed (tachometer signal) is used to determine the frequency of the disturbance.

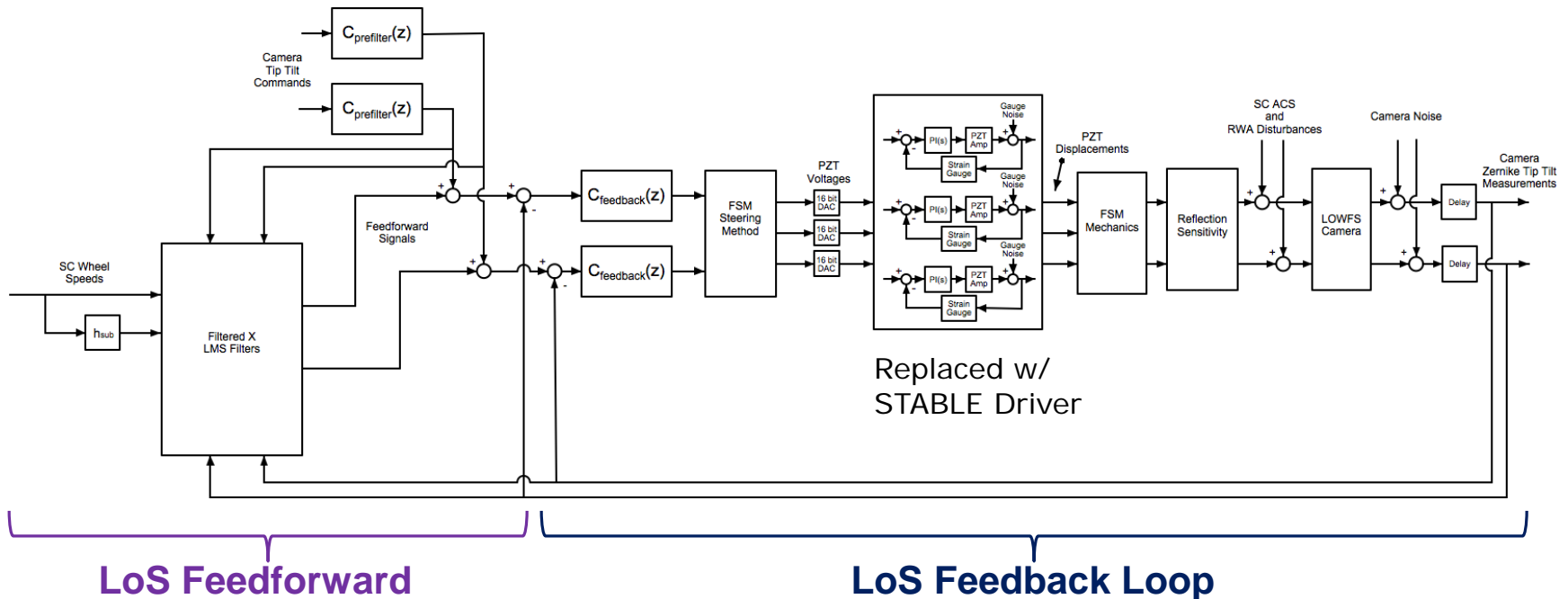



Modeling FSM Loop Correction of CBE LoS Jitter **JPL**

- Residual jitter percentage calculated assuming uniform RWA speed distribution
 - RWA nominal operation speed between 10-40 rev/sec, ramping up in 18 hours
 - Summarized in three residual jitter conditions for coronagraph operation, from the best (0.4 mas) to the worst (1.6 mas)
 - Data editing can be used to discard high jitter images
- Predicted LoS residual jitter allows compelling coronagraph science

X jitter residual over 10-40 rev/sec

Star Mv	<0.4	<0.8	<1.6 milliarcsec
0	95%	98%	100%
3	95%	98%	100%
6	94%	100%	100% - Updated
7	83%	98%	100%
8	59%	97%	100%

Y jitter residual over 10-40 rev/sec

Star Mv	<0.4	<0.8	<1.6 milliarcsec
0	97%	100%	100%
3	97%	100%	100%
6	95%	98%	100% - Updated
7	91%	99%	100%
8	52%	99%	100%

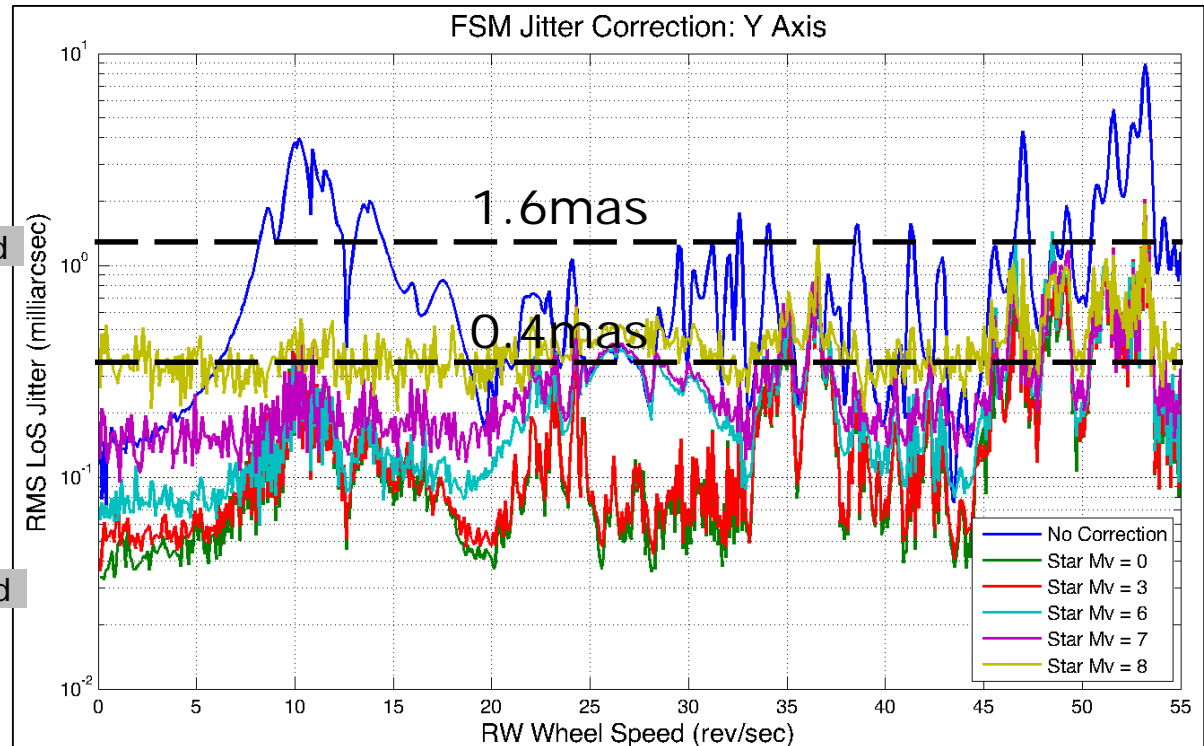

- **Coronagraph/LOWFS focal plane masks**
 - HLC/LOWFS occulter
 - Harder case: occulter center used for coronagraph in transmission, LOWFS in reflections. Performance validated: nulling and LOWFS/C
 - SPC/LOWFS occulter
 - Easier case: coronagraph and LOWFS regions spatially separated on occulter
 - Both masks fabricated at JPL's MicroDevices Lab
- **LOWFS camera.** Used CCD39 for initial demo
 - SciMeasure camera electronics implementation does not meet its $7.5e-$ read noise spec at 1kHz
 - Options that meet spec exist with no new technology (engineering only)
- **Fast Steering Mirror.** High TRL unit built for SIM
 - Performance extensively characterized for WFIRST
 - Low noise FSM driver (from STABLE project)

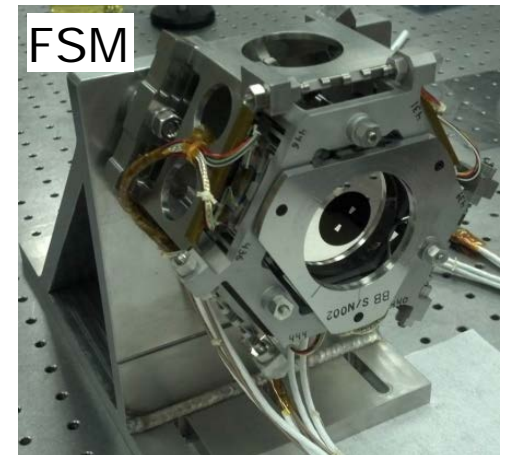
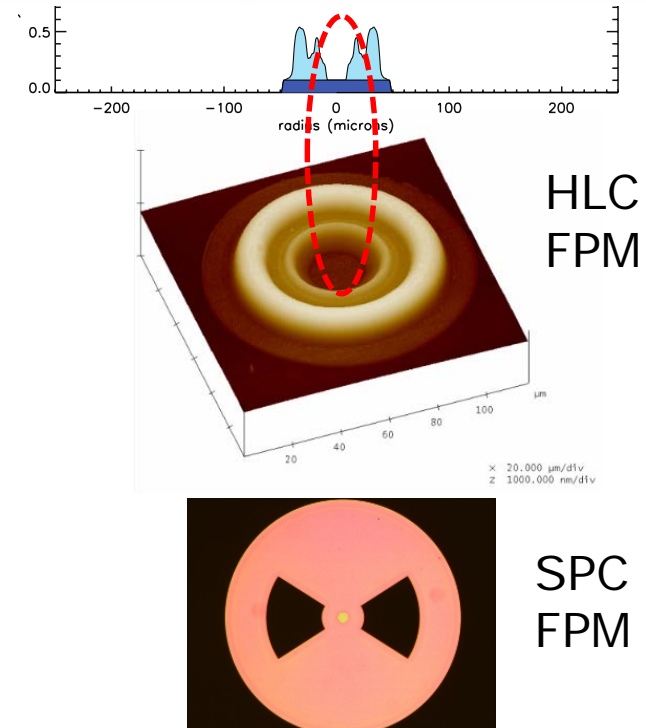

OTA Simulator:

- LoS Jitter & Drift
- LO WFE drift

LOWFS/C Testbed:

- WF sensing with Zernike mask & Camera
- FSM LoS control
- Focus control

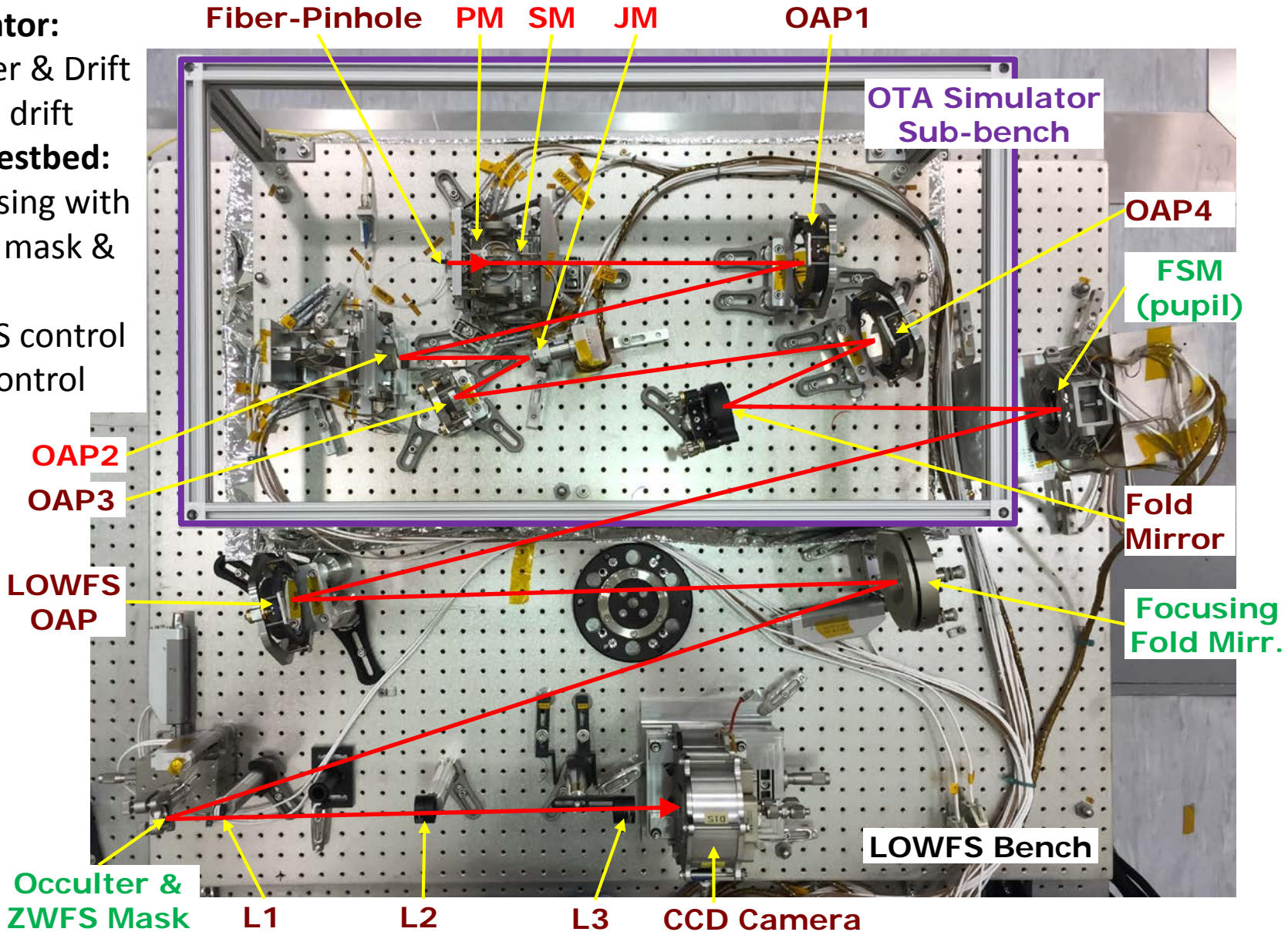

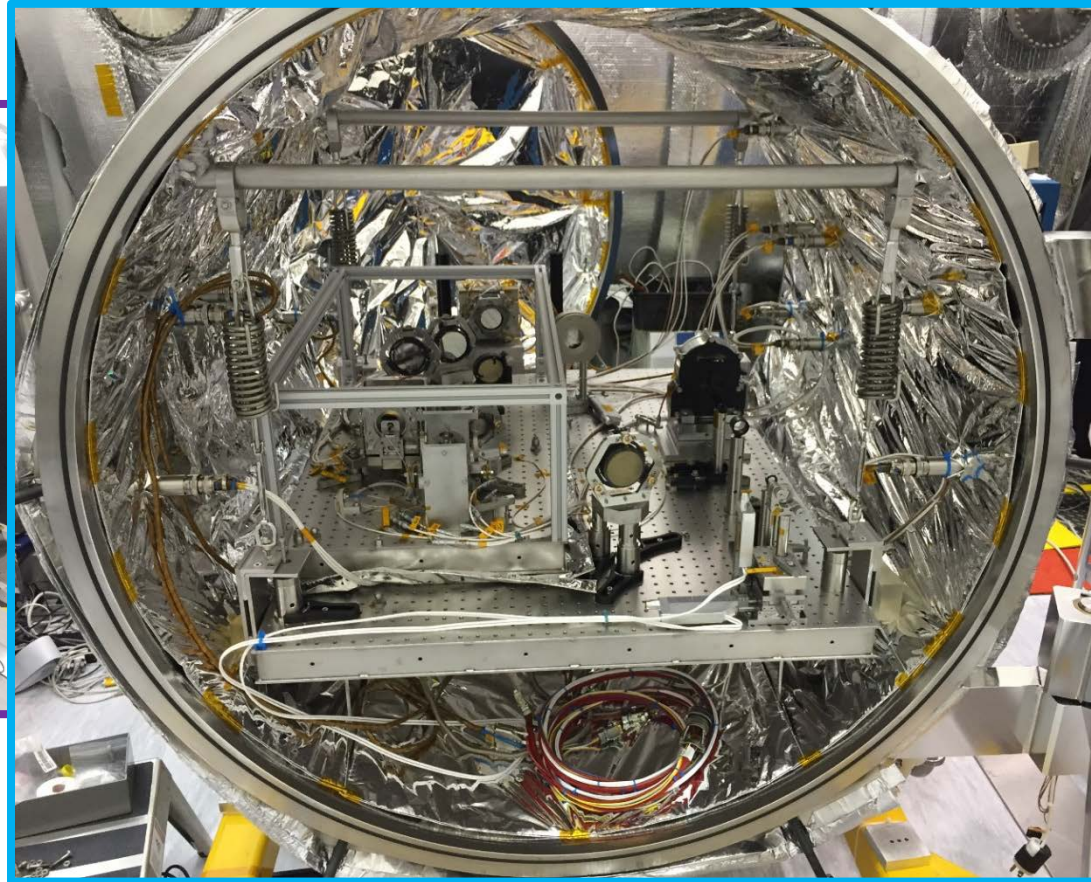

- Initial LOWFS/C vacuum testing done in HCIT facility's small vacuum chamber
- Improved mechanical and thermal isolation, instrumented with accelerometers and thermal sensors
- LOWFS/C vacuum tests is carried between May – Sept of 2015 for Milestone 6

- OTA Simulator is used to generate sub-nanometer WF aberrations and sub-milliarcsecond of LoS tilt
- OTA Simulator is used verify ZWFS performance
- Low order WFE modes are generated by small rigid body motion of powered optics using PZTs
 - LoS tilts (static and dynamic): Z2 and Z3
 - Low order WFE: Z4 (focus), Z5 & Z6 (astigmatism), Z7 & Z8 (coma), Z11 (spherical)
- Zygo in-air calibrations (double pass)
 - Influence function of each PZT actuator.
 - Pure WFE modes Zygo measurement (double pass)
 - $\Delta\text{OPD} = \text{Aberrated}_{\text{OPD}} - \text{Nominal}_{\text{OPD}}$

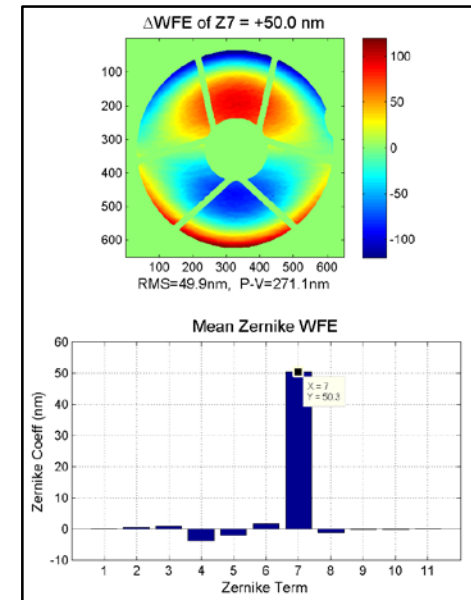
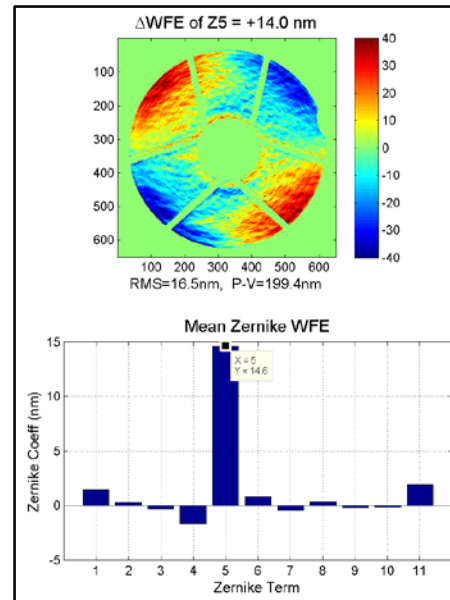
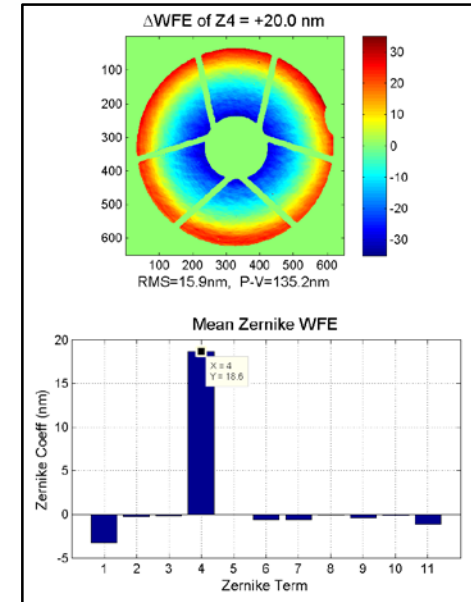
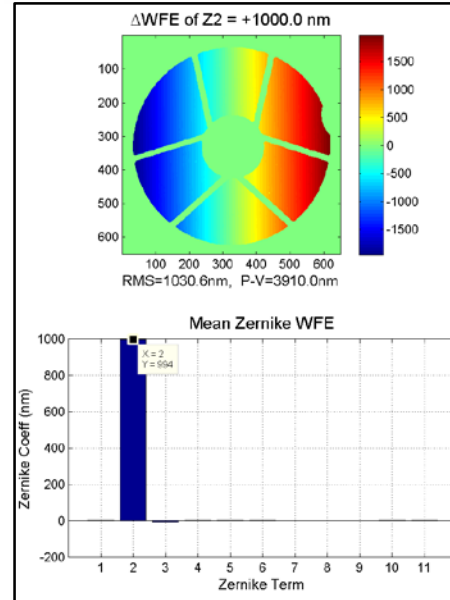



ZWFS Results: Line of Sight Error Sensing

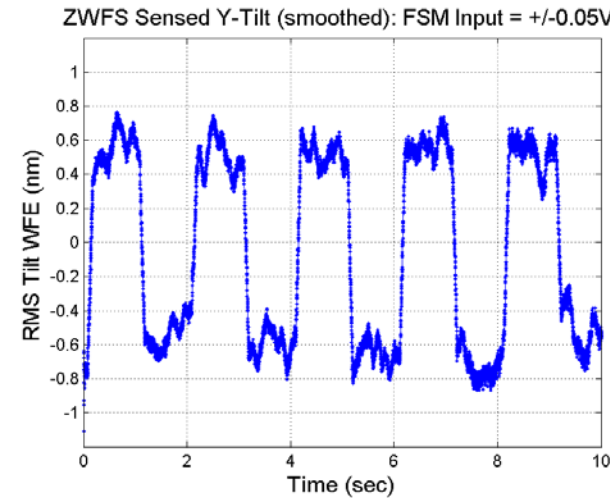
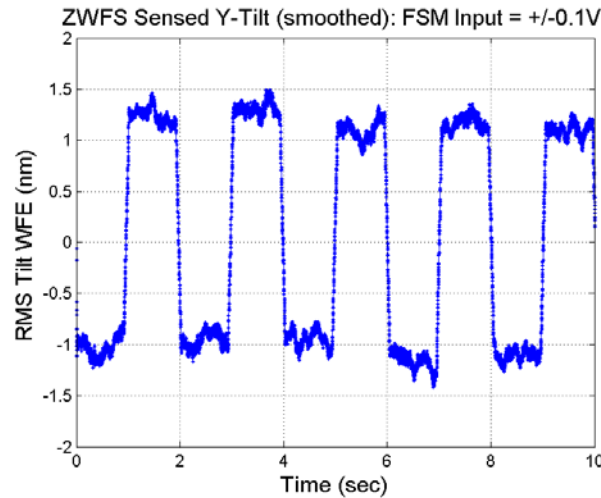
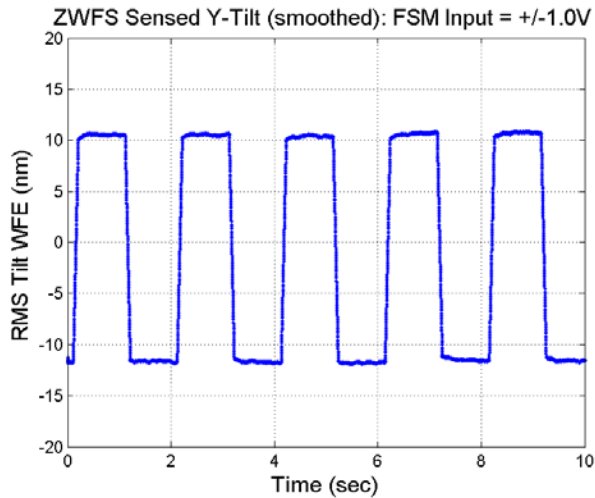
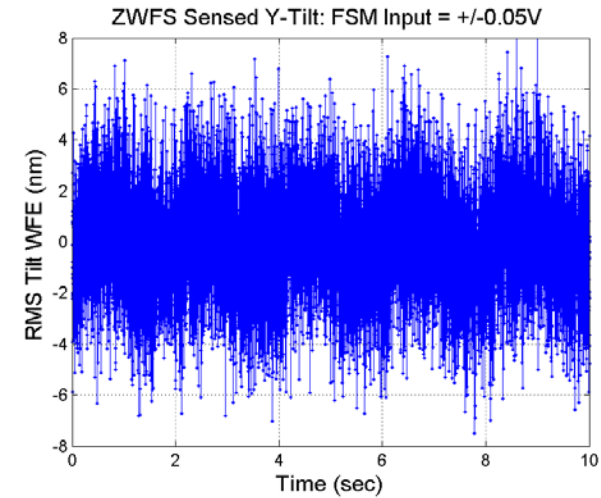
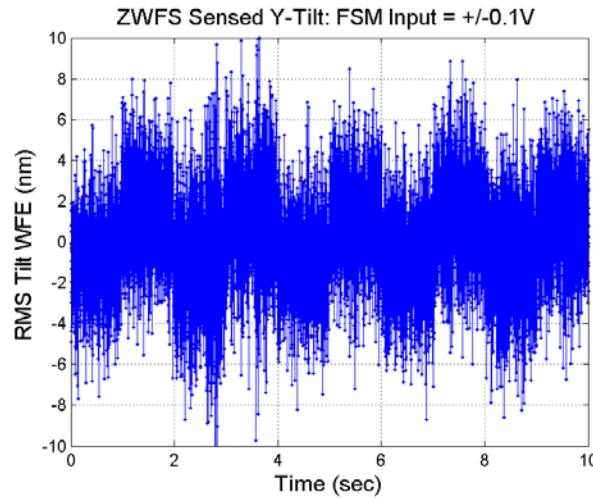
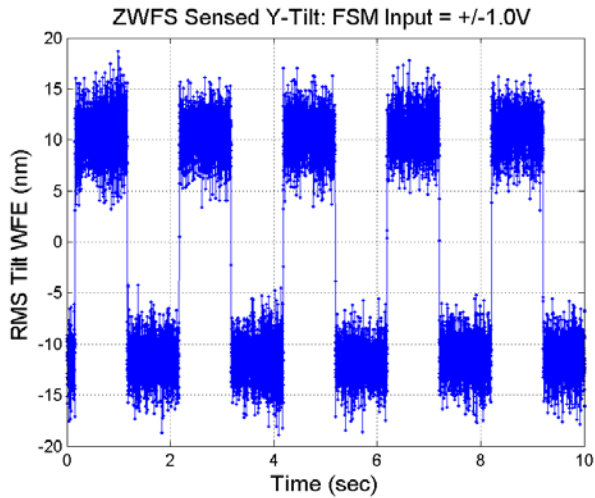

Mean Sep=22.1 nm=7.7 mas

Mean Step=2.2 nm=0.77 mas

Mean Step=1.2 nm=0.38 mas

- Sensor clearly detects ± 0.19 mas on-sky signal (right column)
- ZWFS sensed tilt WFE matches calibrated input to within 8%

Socket Interface
Camera | Camera Setting | FSM Control | FSM Feedback | FSM Pre-Filter | Jitter Mirror

JM Parameters

Wheel Speed: Upload

Query

Channels

Ch1	Ch2	Ch3	
0	0	0	Reset

JM Generation

Off On

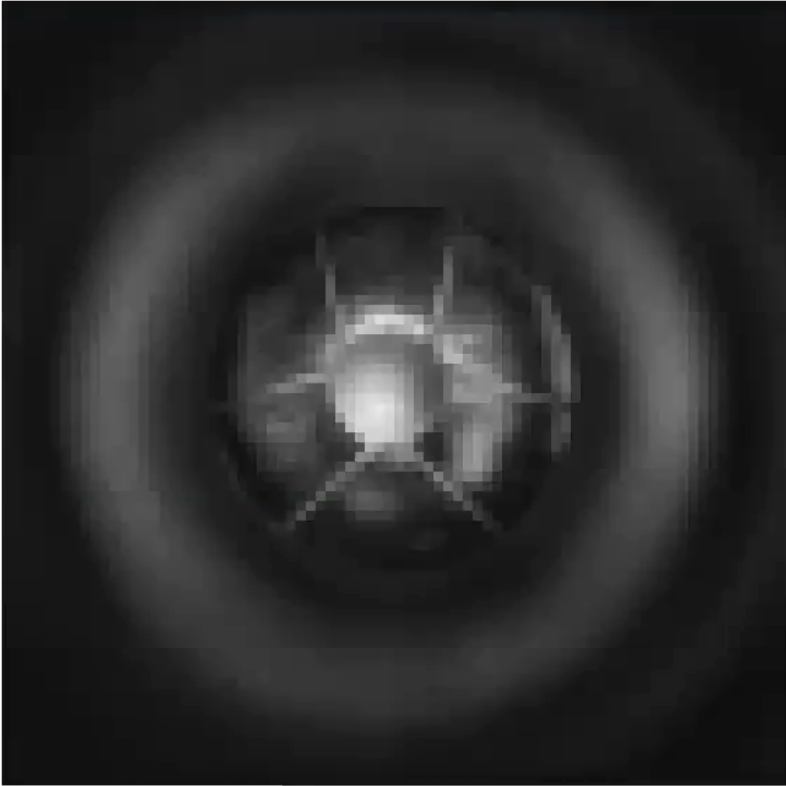

Zernike Terms

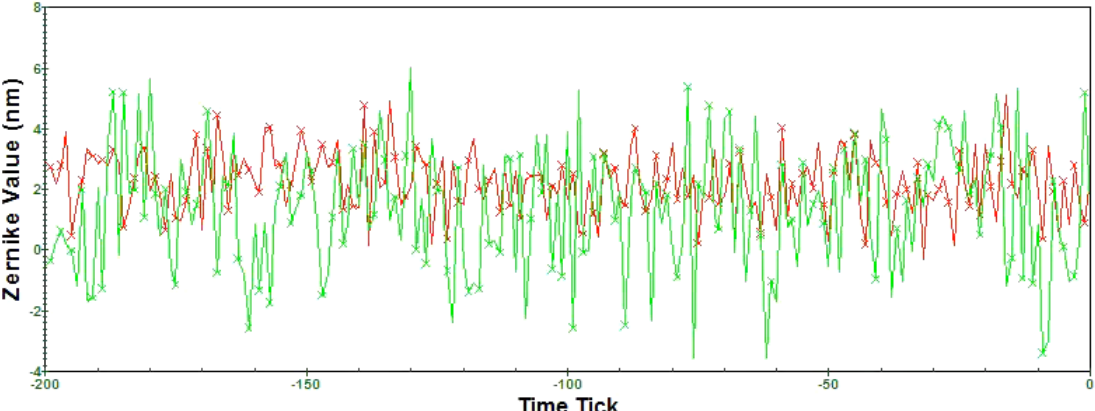

Zernike Coefficient

<p>Z2 Tilt-X 1.450 █ <input type="checkbox"/></p>	<p>Z3 Tilt-Y -2.620 █ <input checked="" type="checkbox"/></p>
<p>WC_fund_X -1.219 █ <input type="checkbox"/></p>	<p>WC_shar_X -0.163 █ <input type="checkbox"/></p>
<p>WC_fund_Y -0.443 █ <input type="checkbox"/></p>	<p>WC_shar_Y 0.002 █ <input type="checkbox"/></p>
<p>WS_fund_X -1.767 █ <input type="checkbox"/></p>	<p>WS_shar_X -0.277 █ <input type="checkbox"/></p>
<p>WS_fund_Y -0.035 █ <input type="checkbox"/></p>	<p>WS_shar_Y -0.261 █ <input type="checkbox"/></p>

Exit

15



Disturbance: WFIRST Cycle 5 CBE

- ACS LoS drift
- LoS jitter @ RW of 10 rev/sec (worst case)
- Small plot shows the zoomed in region

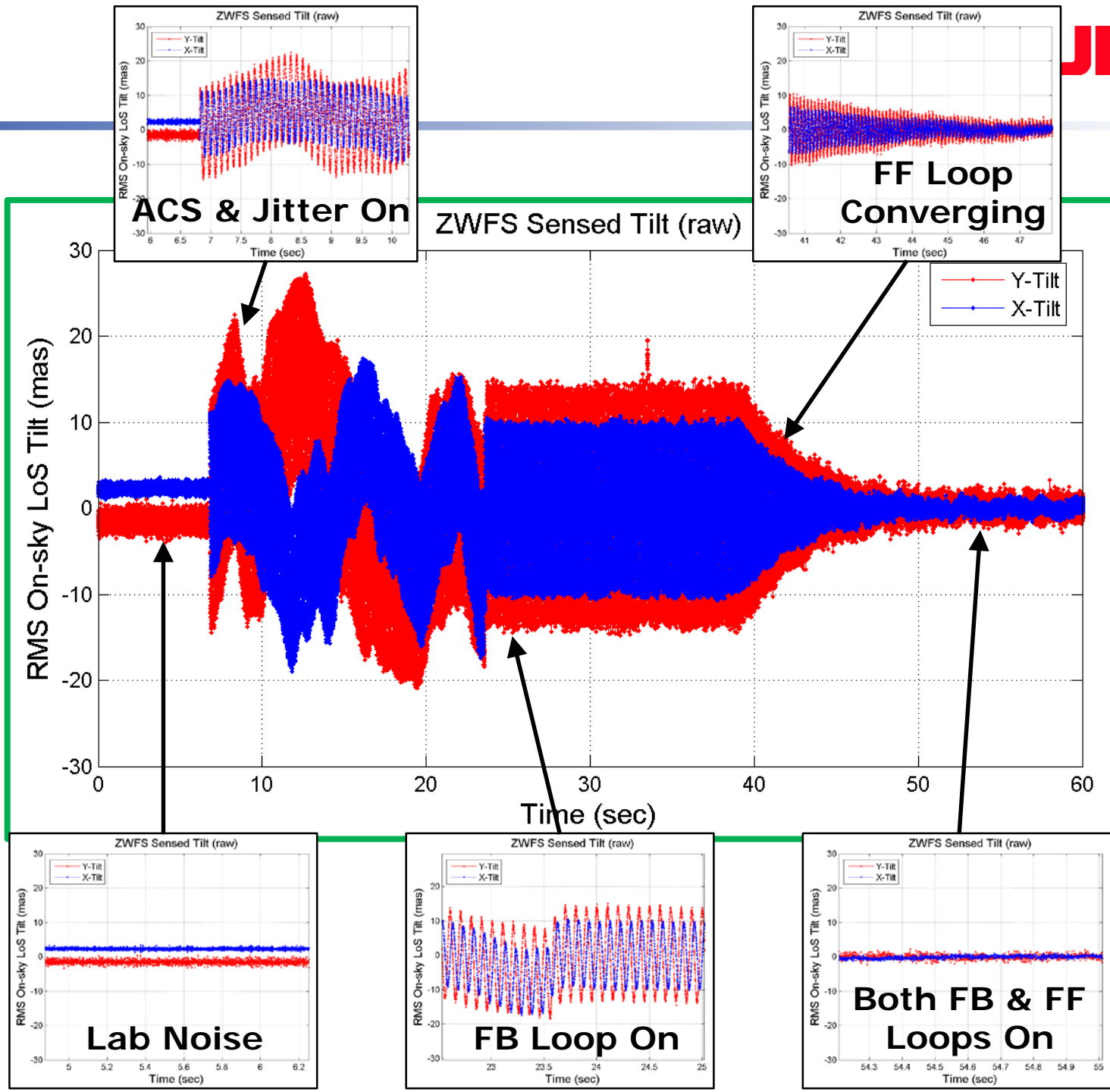

ACS & Jitter On

ZWFS Sensed Tilt (raw)

**FF Loop
Converging**

Lab Noise

FB Loop On

**Both FB & FF
Loops On**



Results: LoS Drift and Jitter Control

14 mas ACS Drift + Cycle 5 CBE Jitter at 600 rpm



- LoS disturbance input:
 - drift (ACS 14 mas rms requirement) + jitter (Cycle 5 CBE with multiple harmonic tones)
 - At wheel speed of 600rpm (10 Hz) the CBE LoS jitter disturbance is the highest
- Post correction residuals are 0.3 mas, ignoring the high frequency (> 150 Hz) lab noise

Open and Closed Loops PSD

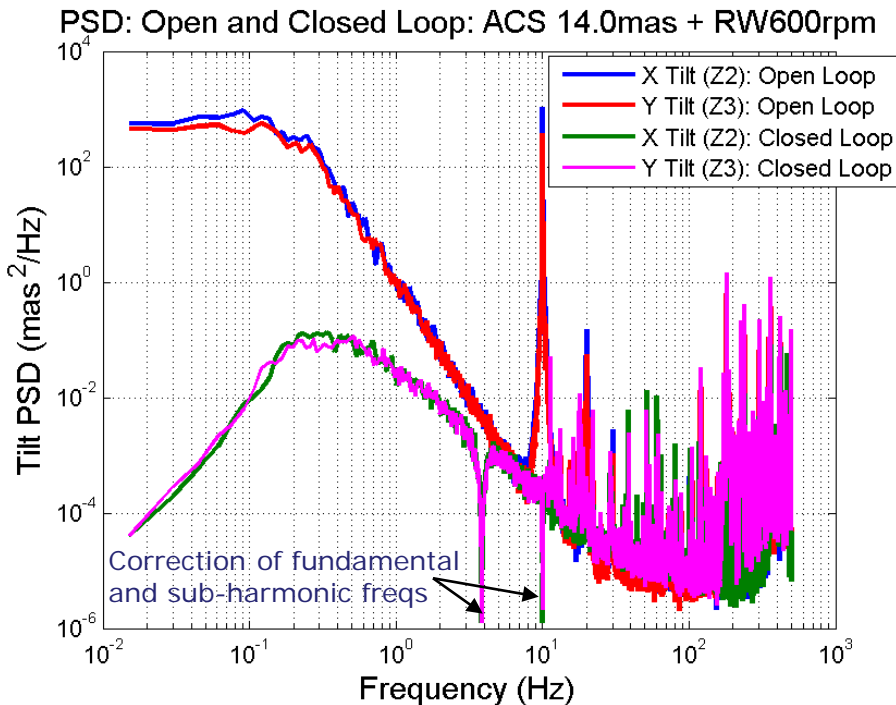

Open and Closed Loops Integrated LoS

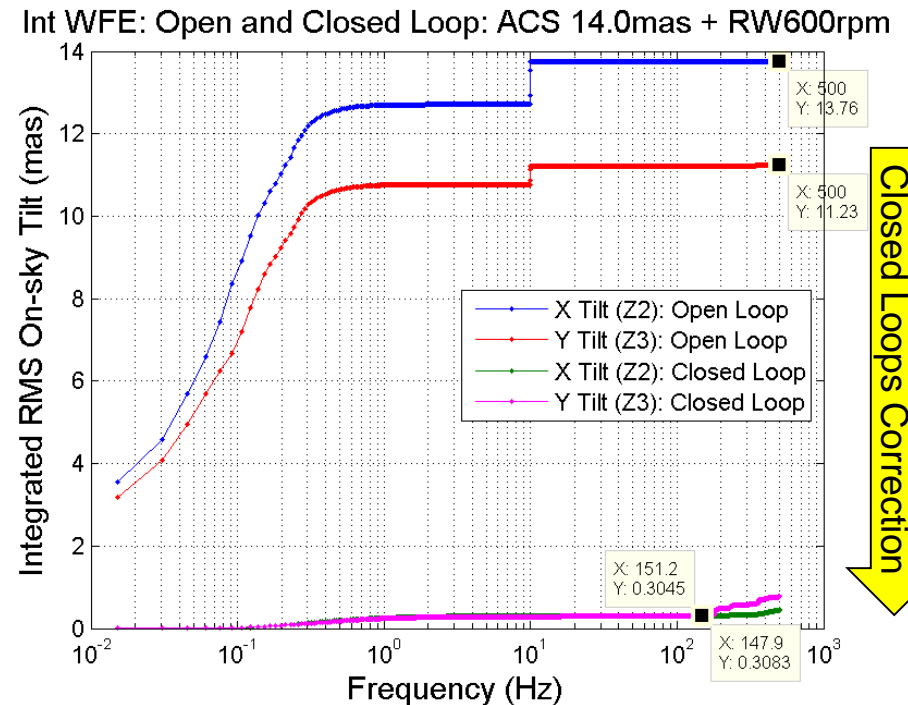

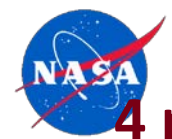

Results: LoS Drift and Jitter Control [4]



4 mas Cycle 5 CBE ACS Drift + Single Tune Jitter 14 mas at 2400 rpm

- LoS disturbance input:
 - drift (ACS 4 mas rms, Cycle 5 CBE) + jitter (single tune at RW speed of 2400 rpm (40 Hz) scaled to 14 mas requirement)
 - Feedforward loop corrects only fundamental tune
- Post correction residuals are <0.5 mas, ignoring the high frequency (> 150 Hz) lab noise

Open and Closed Loops PSD

PSD: Open & Closed Loop: ACS 4mas + RW2400rpm 14mas

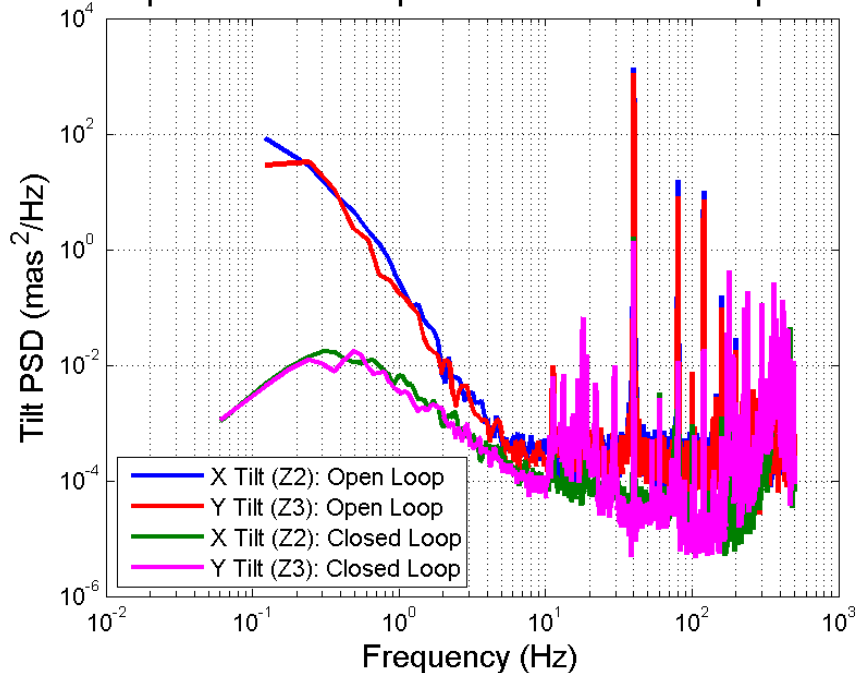

Open and Closed Loops Integrated LoS

Int WFE: Open & Closed Loop: ACS 4mas + RW2400rpm 14mas

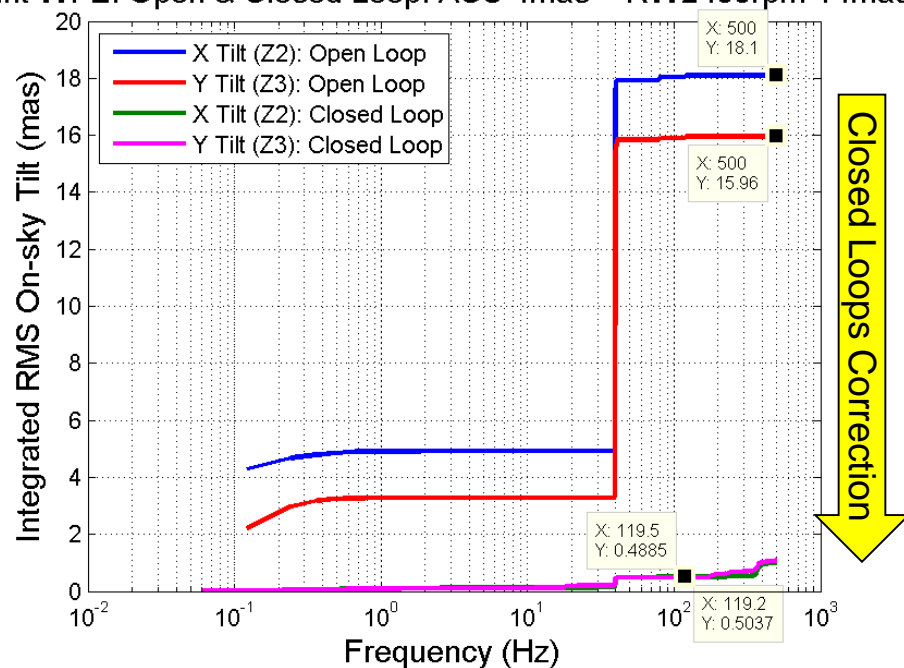

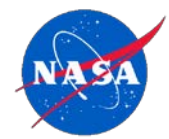

Comparison of Model Predictions and Testbed Results



- The Fast Steering Mirror (FSM) servo model includes:
 - FSM plant model based on laser metrology measurements
 - FSM and Jitter Mirror (JM) to LOWFS/C Zernike wavefront sensor calibration
 - ZWFS sensor noise including camera read out noise
 - ZWFS sensor non-linearity
 - Disturbance generators:
 - WFIRST Cycle 5 CBE disturbance for ACS drift and RWA jitter
 - ACS drift scalable from 0 (no drift) to 14 mas (requirement)
 - Cycle 5 CBE jitter for wheel speed 600 – 2400 rpm (10 – 40 Hz)
 - Single tune jitter scalable from 0 (no jitter) to 14 mas (requirement) with wheel speeds 600 – 2400 rpm (10 – 40 Hz)
 - Model simulates 10+ minutes of data, matching the testbed data duration
- Testbed data:
 - Data taken for 10 min (600 sec) with camera running at 1 KHz frame rate
 - 10 section PSD averaged
 - Testbed data contains the lab environmental noise from various sources



Compare Model and Testbed Results:



Open and Closed Loop PSD and Error Transfer Function

RWA Speed 600 rpm

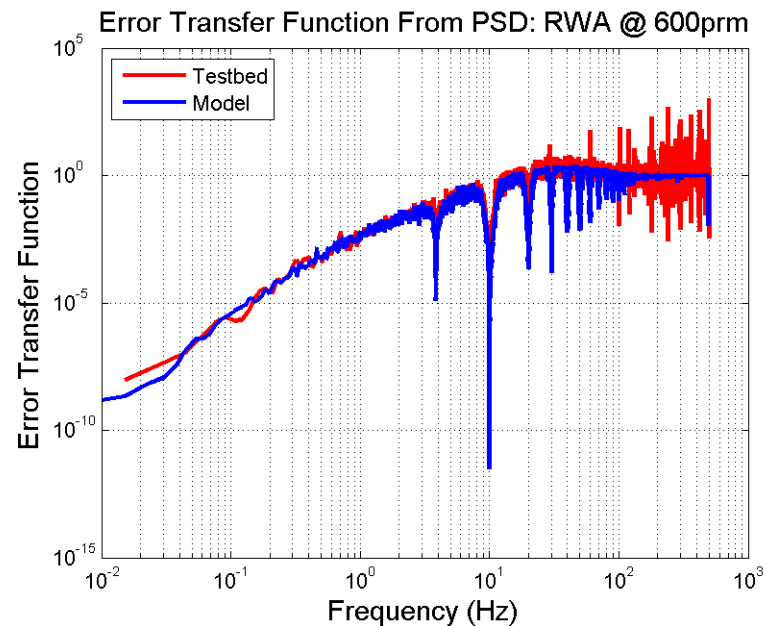
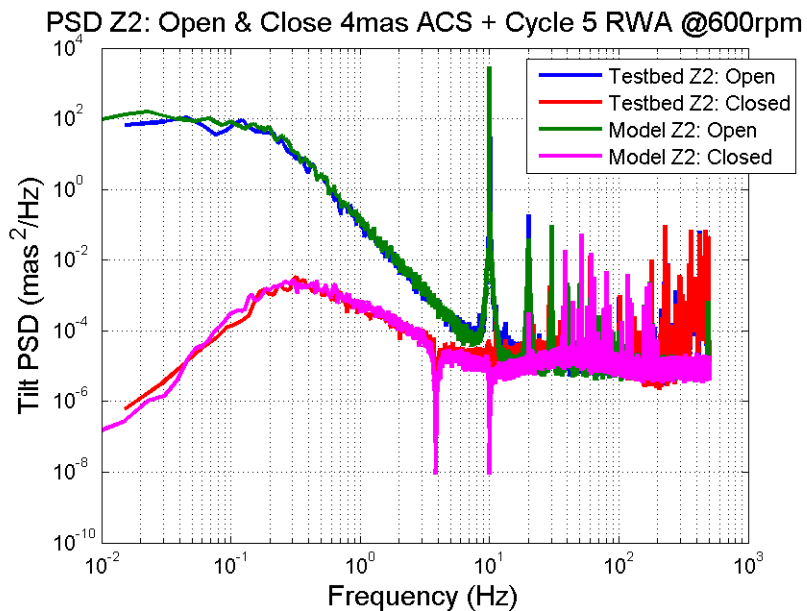

RWA Speed 1300 rpm

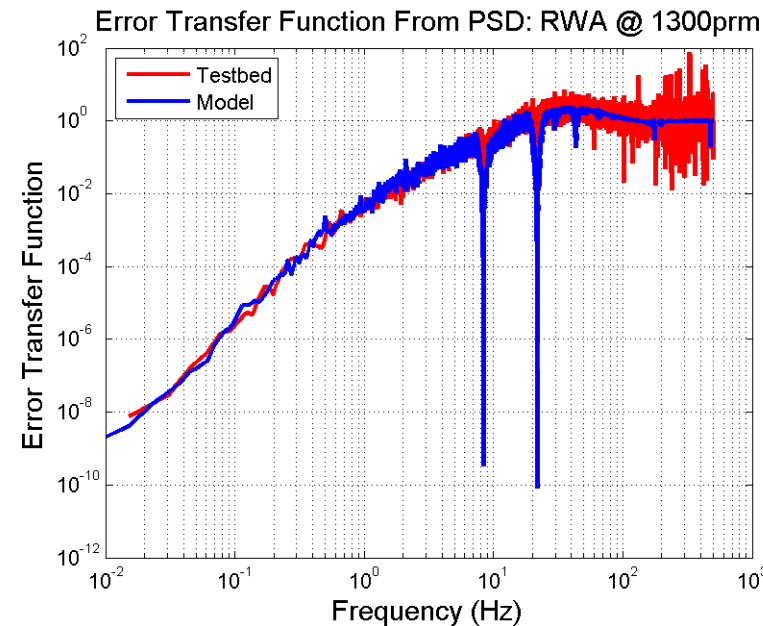
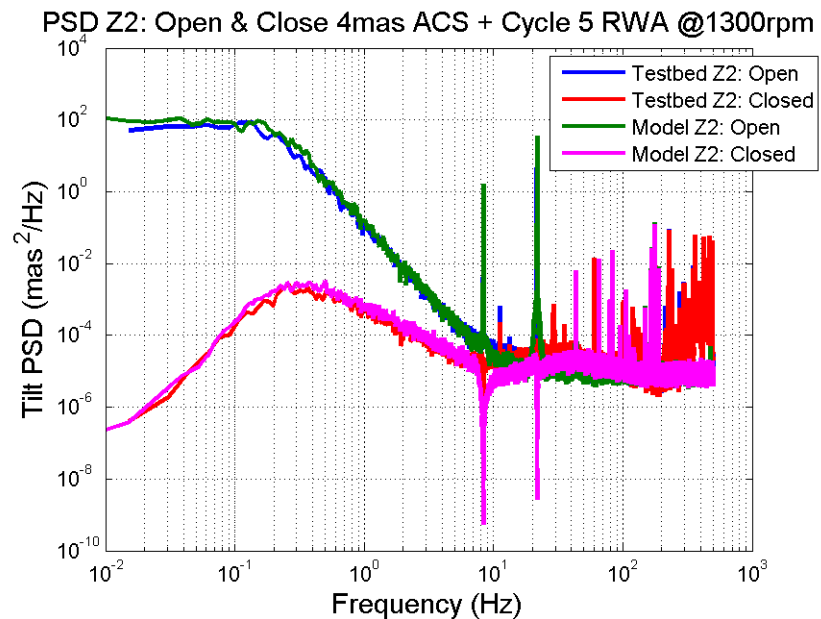

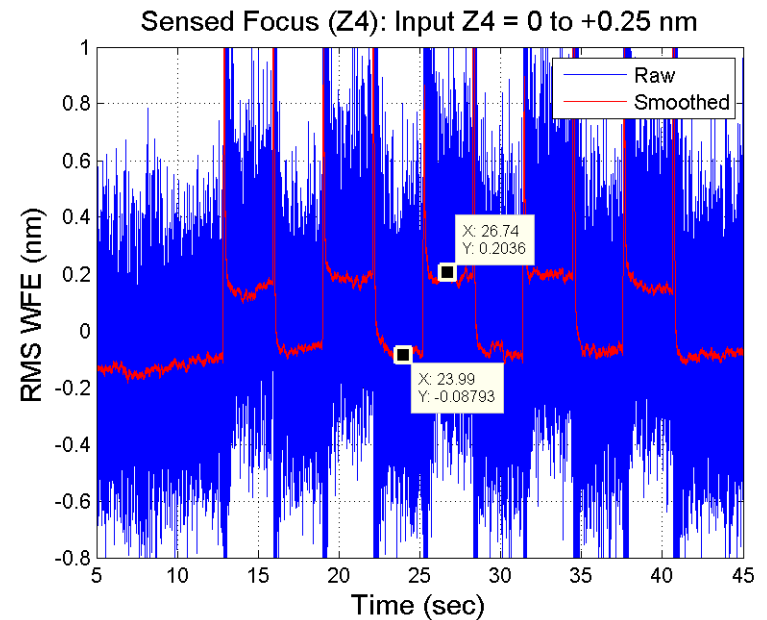
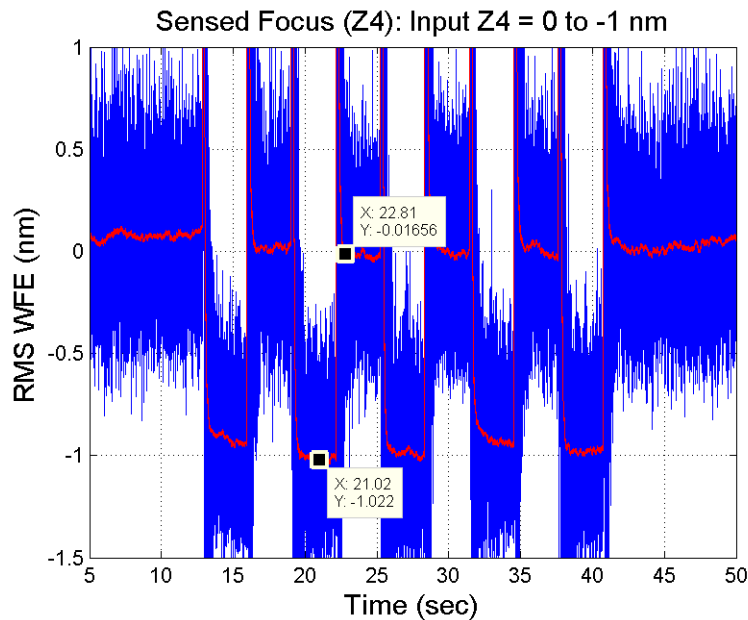

- Square wave modulation of the focus term: 1nm p-v (left) and 0.25nm p-v (right)
- Sensor clearly detects these small focus changes.
- Observed high frequency noise and step spikes caused by:
 - Camera read-out noise (exceeds spec at 1 kHz)
 - Environmental noise
 - PI PZT driver command implementation (RS232 applies PZT commands sequentially, causing transition spikes)
- Plan in place to reduce all of these noise sources on the dynamic OMC testbed

ZWFS sensed focus changes match calibrated input to <10%

- **Zernike wavefront sensor (ZWFS) selected for the WFIRST Occulting Mask Coronagraph (OMC)**
 - OMC includes Hybrid Lyot Coronagraph (HLC) and Shaped Pupil Coronagraph (SPC)
 - Uses starlight rejected by coronagraph focal plane masks
 - Zernike mask designed into the coronagraph occulter, a design that reduces non-common path error
 - Unique LoS control architect with both feedback and feedforward control to minimize sensor noise and suppression high speed LoS jitter
 - Performance extensively modeled, enables meeting OMC science goals
- **WFIRST optical telescope assembly simulator and stand-alone LOWFS/C testbed built, aligned, calibrated. OTA simulator:**
 - Injects low order wavefront drift and line-of-sight (LoS) drift and LoS jitter terms expected on-orbit. Will serve as coronagraph front end during technology development and flight build phases
- **Pointing error sensing to <0.2 mas demonstrated**
- **LoS drift + jitter closed loop demonstrated: ~ 0.3 mas rms per axis residual**
- **LOWFS/C and OTA Simulator is now integrated into the OMC testbed**

- **WFIRST Coronagraph low order wavefront sensing and control technology can be used for large segmented telescope**
 - Use the rejected star light
 - Can build the Zernike phase mask onto the occulter
 - ZWFS can sense LoS drift and jitter
 - ZWFS can sense segment relative tip-tilt-piston drift and jitter
 - Use the control architect with both feedback and feedforward control to minimize sensor noise and suppression high speed LoS and segment jitter
- ***Acknowledgement***
 - *Presented WFIRST coronagraph technology development work was carried out at the Jet Propulsion Laboratory using funding from NASA SMD and STMD*
 - *JPL Document Review Approval: CL#16-0893, CL#15-5812, CL#15-3605*

BACKUP

- Spacecraft ACS drift CBE = 4 mas per axis (Cycle 5 modeling)
- Requirement = 14 mas (assume same PSD shape, scaled up)

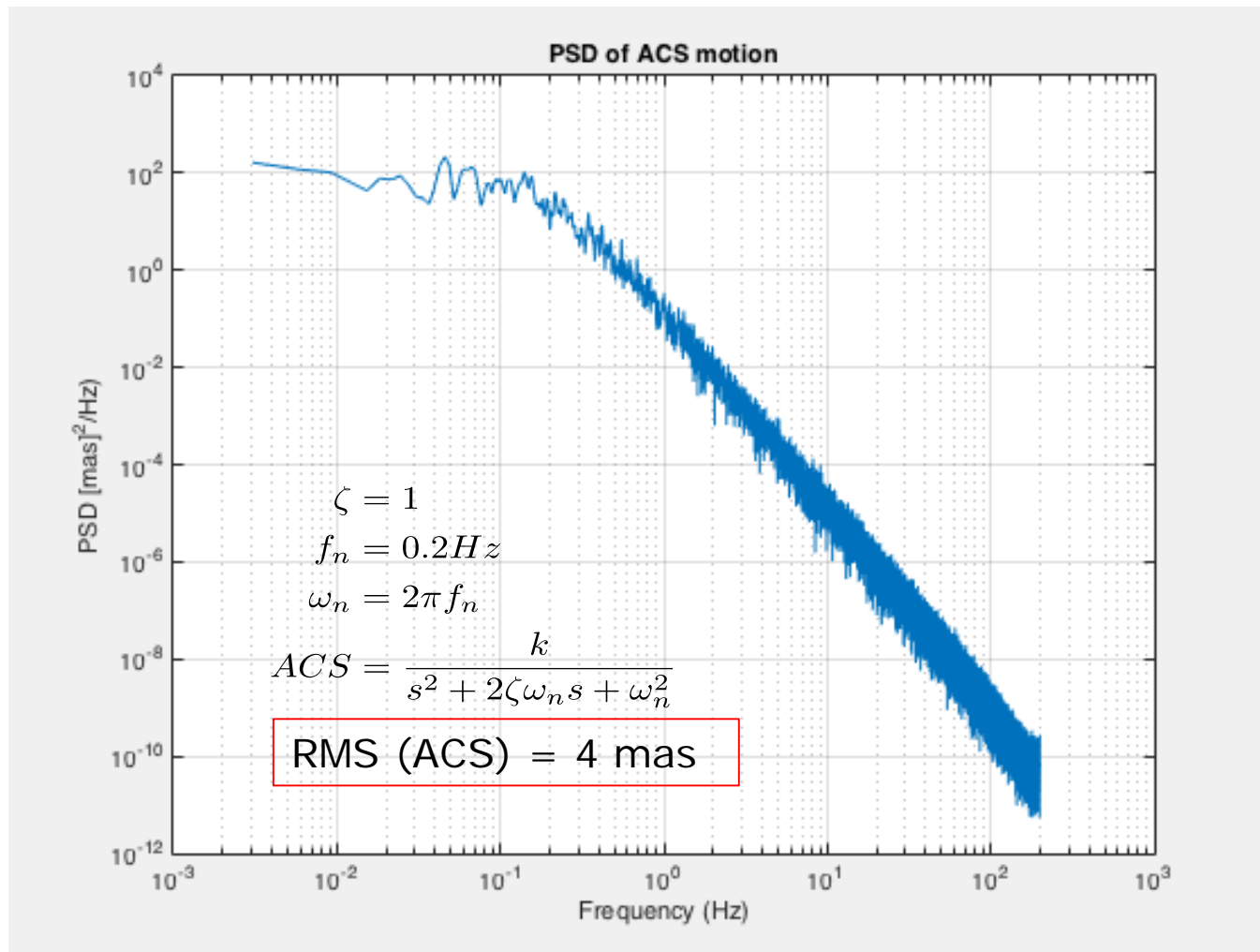

- CBE: Cycle 5 worst wheel disturbance model, includes MUF
 - Multiple harmonics with most energy in the first two harmonics
- Requirement: 14 mas tone between 10 and 40 Hz

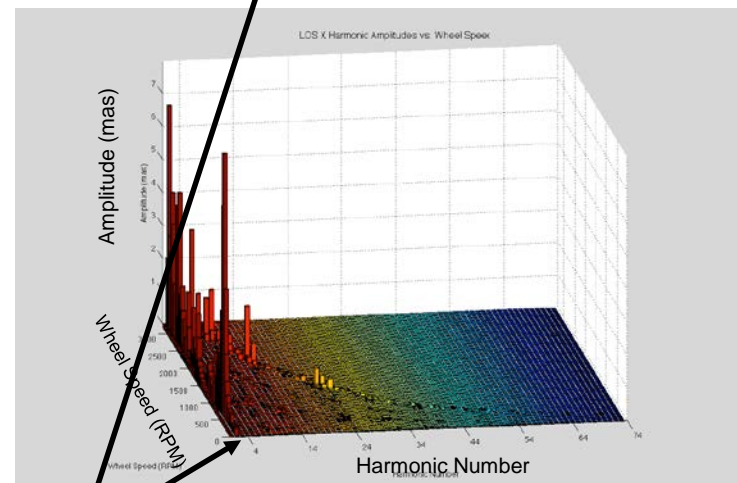
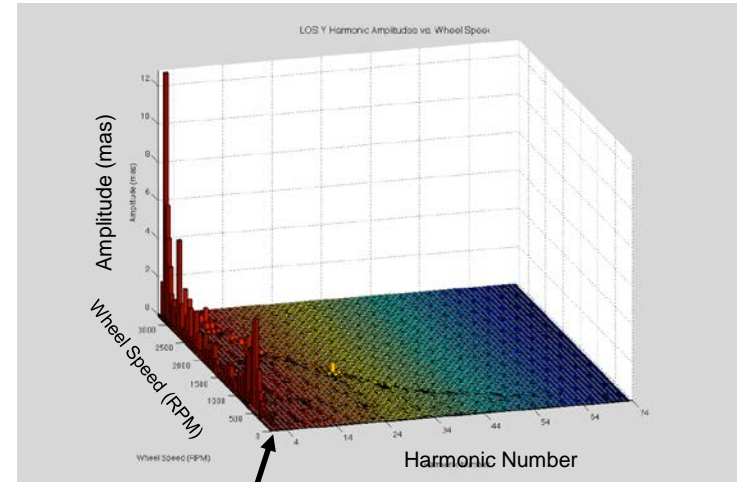
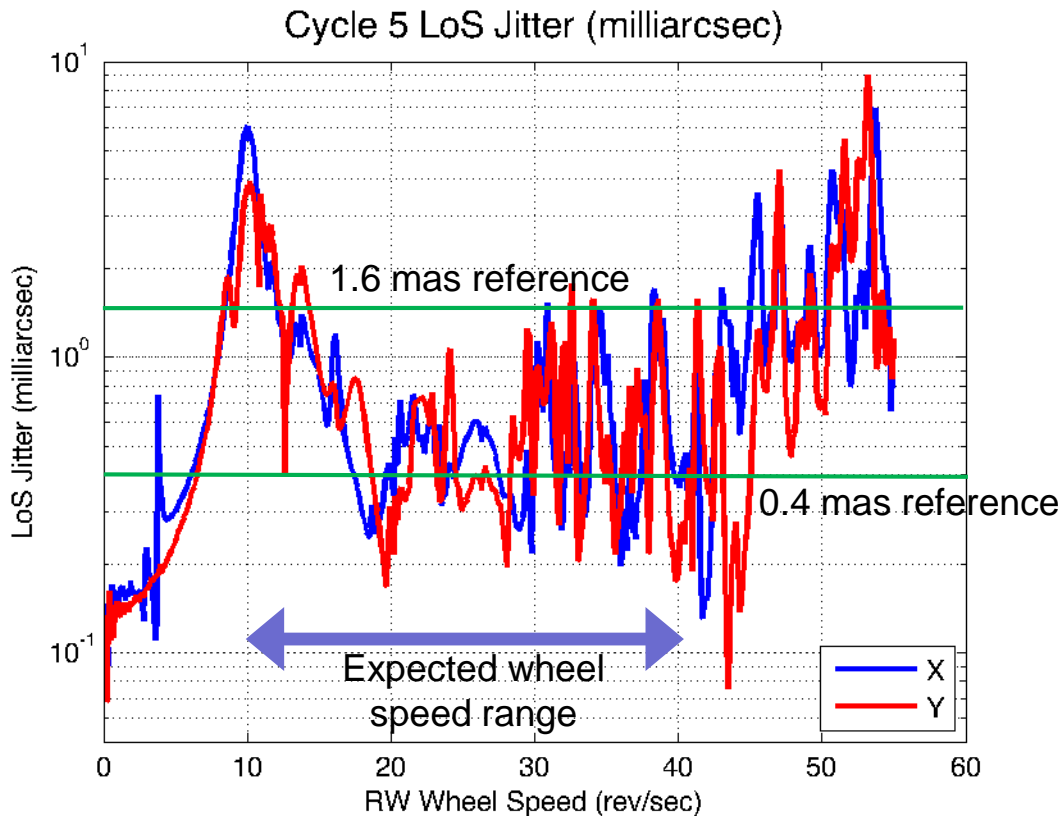

Most of the energy is in the first two harmonics.

- Number of known RV planets detectable in <1 day by HLC and SPC as a function of jitter and post-processing gain [W. Traub et. al., JATIS]
- Residual jitter of 1.6 mas rms per axis allows OMC to produce compelling science; selected as the requirement
- Residual jitter of 0.4 mas rms per axis selected as the goal

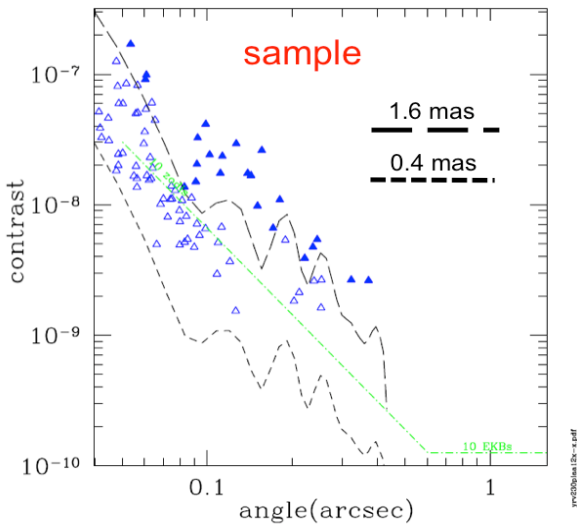

Legend:

- Dotted lines represent contrast achievable with the stated pointing performance
- Triangles represent known target star/planet contrasts

RMS jitter (mas)	post-processing factor (fpp)	# RV planets detected by HLC in <1 day each	# RV planets detected by SPC in <1 day each
1.6	10	13	11
0.8	10	14	13
0.4	10	14	14

1.6	30	14	15
0.8	30	15	15
0.4	30	15	15

HLC and SPC WFE sensitivities modeled by J. Krist

- Compared to 2013 ACWG down select, HLC sensitivities are lower, SPC sensitivities higher (performance trade-off with the addition of Lyot stop)
- Sensitivity highest to spherical and coma

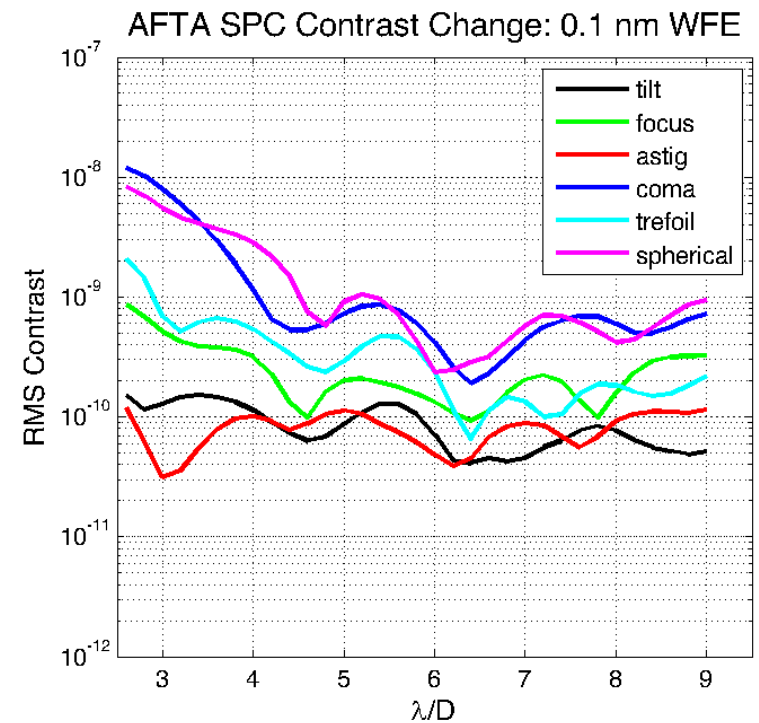
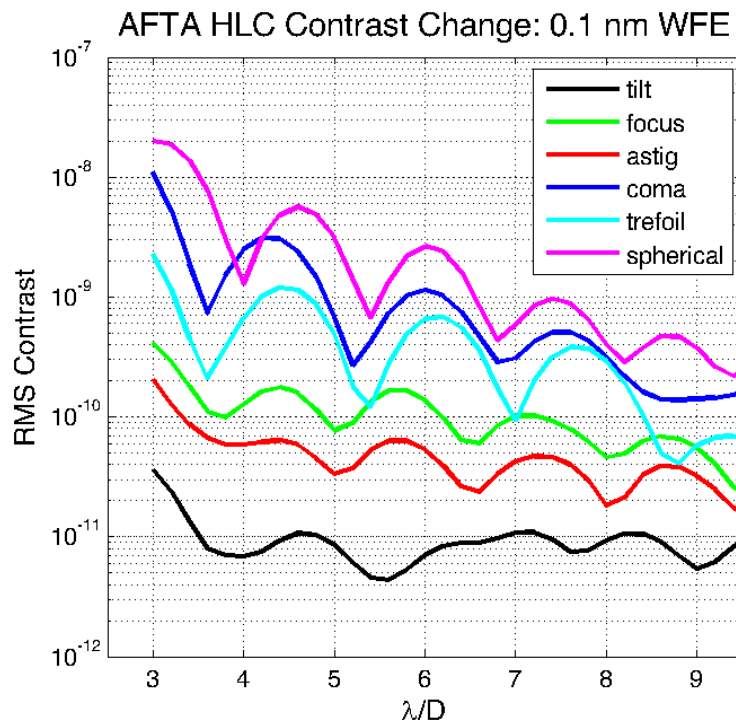

- Expected RWA operating range: 10 - 40 Hz over 18 hours, with MUFs.
- Impact on OMC modeled by J. Krist

AFTA WFE Jitter Zernike Decompositions vs Wheel Speed

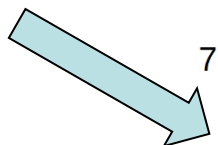
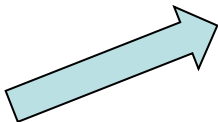
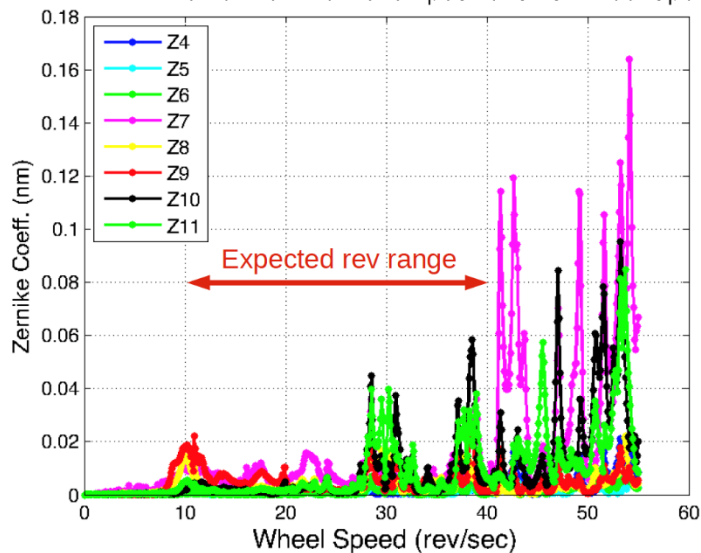

HLC with/without WF Jitter
523 – 578 nm, no pointing jitter, HLC 20140623-139

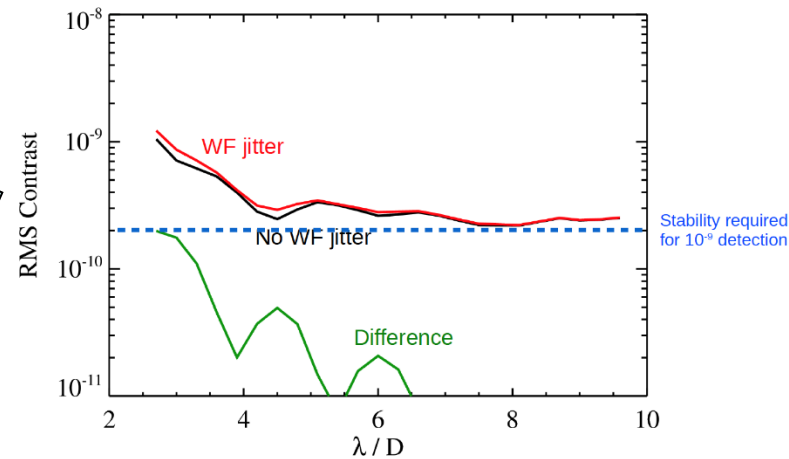

SPC with/without WF Jitter
728 – 872 nm, no pointing jitter, SPC 20140902-1

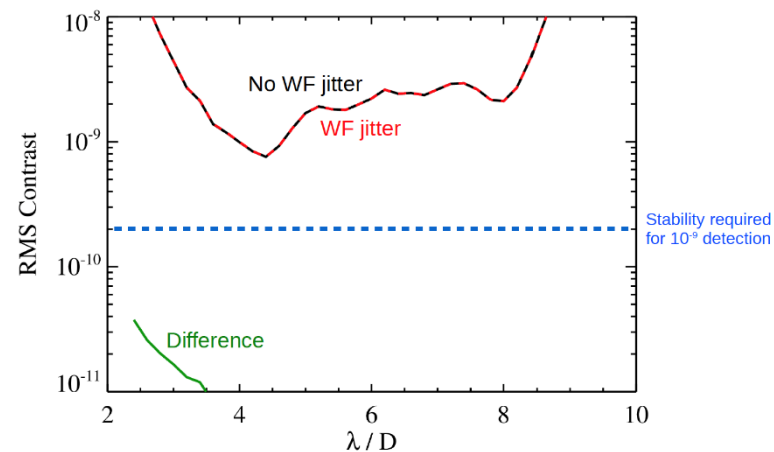

- WFE jitter is not significant error budget contributor
 - except HLC @ $3\lambda/D$
- WFE jitter sensing and correction not baselined for OMC

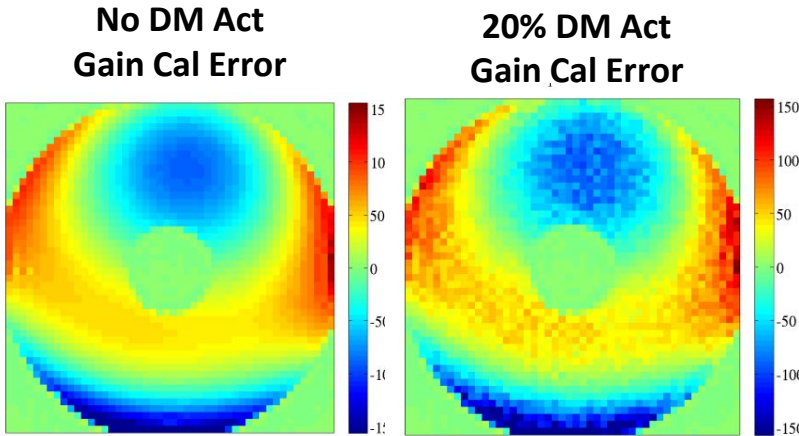

RMS Contrast Changes with LOWFS/C WFE Correction using a DM with Different Act Gain Errors

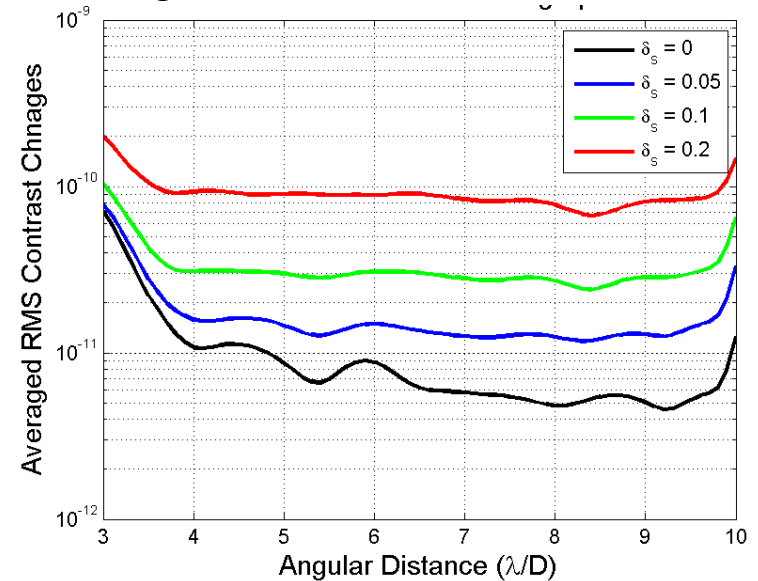

- LOWFS/C needs to correct thermally induced WFE beyond tip/tilt and focus
- This requires the use of the DM in coronagraph – open loop for mid-high order modes during science observations
- Extensively modeled LOWFS/C WFE control including ZWFS sensor, DM, and coronagraph, including DM actuator gain calibration errors, driver quantization
 - Negligible impact on contrast with conservative 10% actuator gain errors and 16-bit DAC
- **Using DM for Z5-Z11 drift correction works well based on modeling, will be experimentally demonstrated for Milestone 9**



Results: LoS Drift and Jitter Control

14 mas ACS Drift + Cycle 5 CBE Jitter at 1300 rpm



- LoS disturbance input:
 - drift (ACS 14 mas rms requirement) + jitter (Cycle 5 CBE with multiple harmonic tones)
 - At wheel speed of 1300rpm (21.7 Hz) the CBE LoS jitter disturbance is very quiet
- Post correction residuals are < 0.3 mas, ignoring the high frequency (> 150 Hz) lab noise

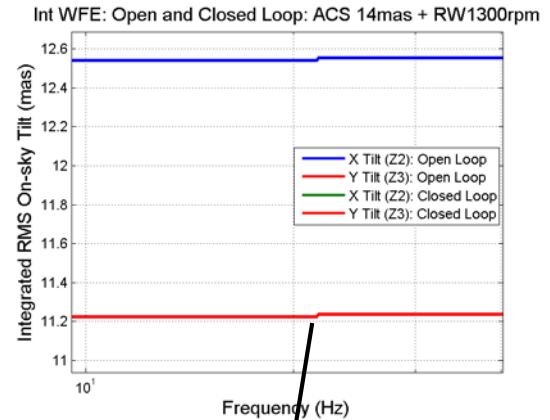

Open and Closed Loops PSD

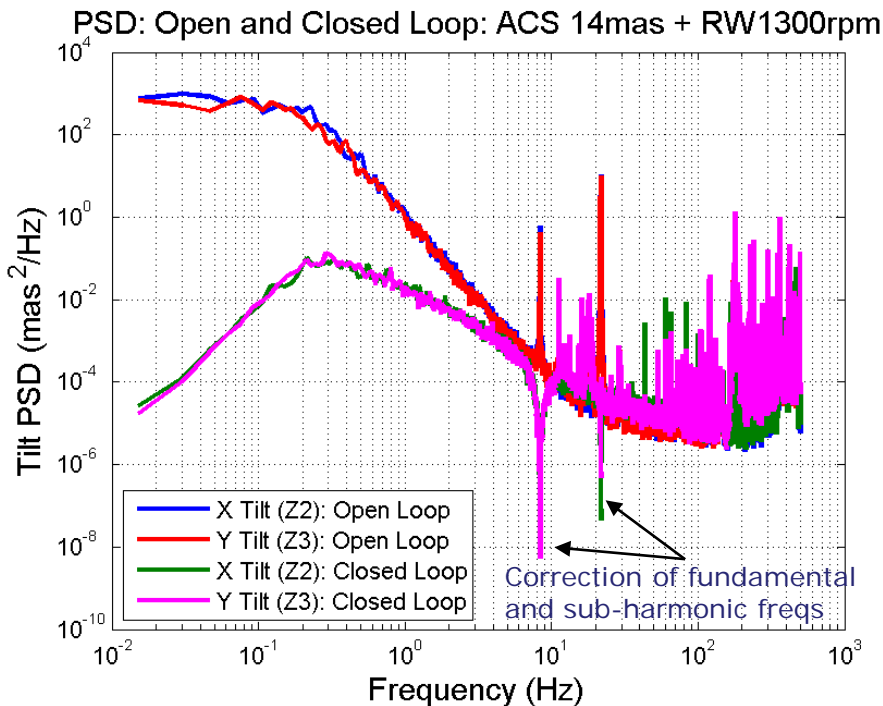

Open and Closed Loops Integrated LoS

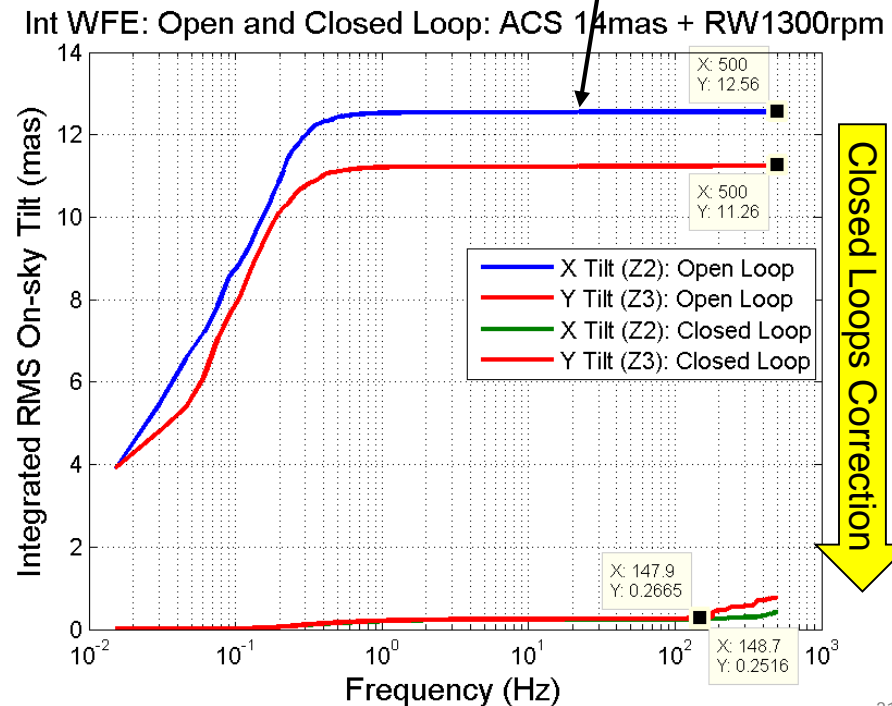



Results: LoS Drift and Jitter Control [3]



4 mas Cycle 5 CBE ACS Drift + Single Tune Jitter 14 mas at 600 rpm

- LoS disturbance input:
 - drift (ACS 4 mas rms, Cycle 5 CBE) + jitter (single tune at RW speed of 600 rpm (10 Hz) scaled to 14 mas requirement)
 - Feedforward loop corrects only fundamental tune
- Post correction residuals are <0.3 mas, ignoring the high frequency (>150 Hz) lab noise

Open and Closed Loops PSD

PSD: Open & Closed Loop: ACS 4mas + RW600rpm 14mas

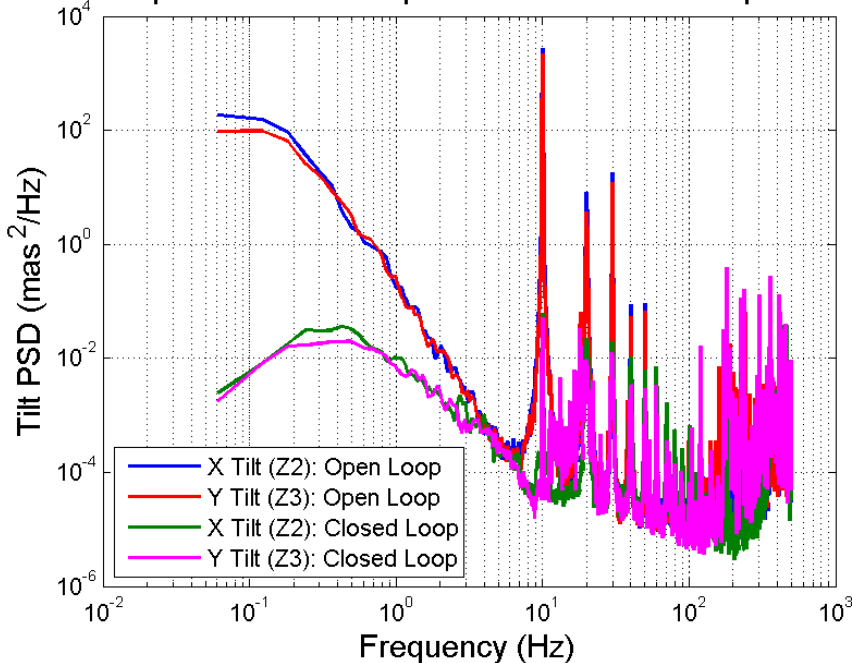

Open and Closed Loops Integrated LoS

Int WFE: Open & Closed Loop: ACS 4mas + RW600rpm 14mas

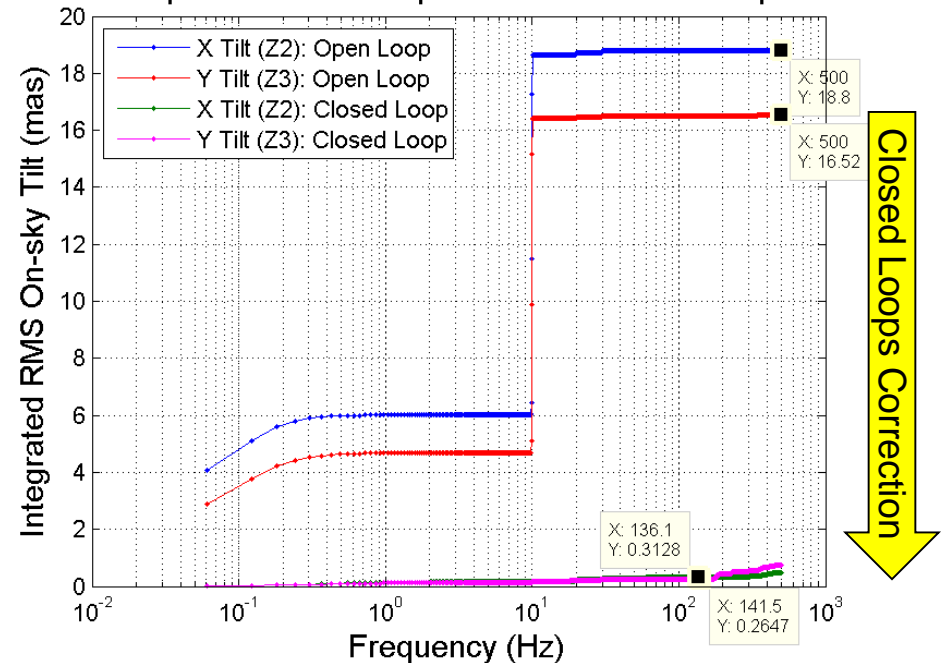



Integration HCL, SPC, LOWFS/C to OMC



SPC Static
Contrast Demo

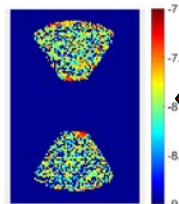

HLC Static
Contrast Demo

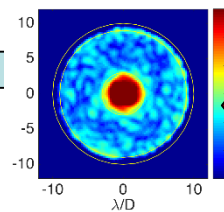

OTA Simulator
Built; LOWFS/C
Initial Demo

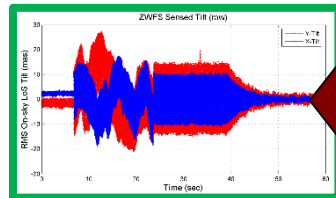
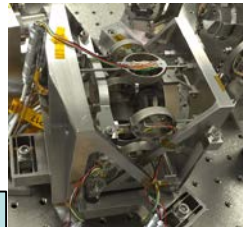

OMC
Testbed Build

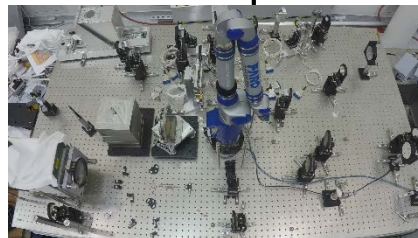

PISCES IFS
(from GSFC)

Coronagraph/
IFS Testbed
Integration

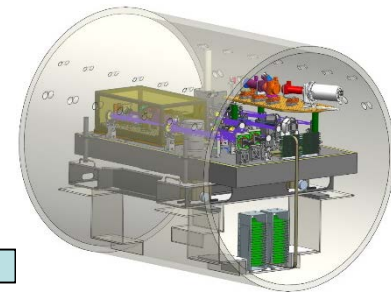

Dynamic OMC
Contrast Demo



- OMC + IFS
Contrast Demo
- Low Photon
Flux Demo

Milestone 9
TRL 5

TRL 6

From subsystem
development/testing to
increasingly high fidelity
testbed demonstrations

FY'15

FY'16

FY'17